



Since 1949



**About Us**

In 1949 Edward L. Pucel founded Pucel Enterprises Inc. on the principle that a superior product insures life long customers. We have maintained this for over 60 years. He then set out to produce a line of all welded heavy gauge steel products. Unique to the industry, we can produce our standard equipment or custom engineered products in mass or in small quantities. Please take a moment to browse this literature and see for yourself the Pucel difference.

**Prices**

All prices are F.O.B. OUR PLANT, CLEVELAND, OHIO; and subject to change without notice; and they do not include any applicable taxes, duties, or any government charges. We reserve the right to invoice at the prices prevailing at the time of shipment.

**Specifications**

Specifications are subject to change without notice. Due to minor design changes, equipment may not conform exactly to photographs in catalog.

**Routing**

Shipment will be made the best way by commercial carriers; U.P.S. or parcel post is shipped prepaid. When shipment is prepaid at the customer's request, a separate invoice will be submitted, which must be paid within 15 days of invoice date; except however, U.P.S. and parcel post charges will be added to the original invoice.

**Packaging**

All items are packaged for domestic shipment. Additional charge will be made for special packaging.

**Damaged Goods**

When damage is noted on delivery, the carrier agent is to make the damage notation on your delivery receipt. **DO NOT SIGN THE DELIVERY RECEIPT UNLESS THIS IS DONE.** The consignee must make claim directly and promptly to the carrier for any damage. When damage is not discovered until all of the items are unpacked, request must be promptly submitted to the carrier for concealed damage inspection. All items are thoroughly inspected prior to shipment.

**Changes and Cancellations**

Items designed as special or modified catalog items are not subject to change or cancellation as they are manufactured for each individual order.

**Corrections**

Stenographic, clerical, or any other errors, are subject to correction

**Delays**

All orders, contracts and agreements are made subject to delays contingent upon accidents, strikes, embargoes, or any other causes beyond our control.

**Terms**

All prices are NET - 30 days from date of invoice. A 1% cash discount is allowed if payment is made within 10 days from date of invoice. Open account can be established with an acceptable Dun and Bradstreet rating. Firms listed and not rated, or not listed, are requested to submit three major trade references and one banking reference with their order to facilitate prompt handling.

**Overview**

These said "Sales-Terms and Conditions" apply to all of the equipment (Standard, Modified and Special), and related matters in this catalog, and are subject to the pricing as contained in the current Price List and subsequent Price Lists as issued from time to time, which may be issued without notice.

**Guarantee**

All Pucel Equipment is fully guaranteed to be manufactured in accordance with commercial standards and specifications shown in our catalog. Equipment is fully inspected before leaving our plant and is guaranteed against defective workmanship for 3 months from date of purchase. However, we cannot be held responsible for abuse by user beyond normal usage. This is your guarantee of a product of highest quality.

**Returned Goods**

All items returned without our written permission will be refused. Request for return of goods must be made within 10 days of the receipt of goods. A 15% handling and reconditioning charge will be made on authorized returned items. Goods must be returned pre-paid at customers expense. Special items, or modified catalog items, are not returnable.



**Stainless Steel**

Stainless Utility Carts & Tables, Stock Carts ..... 4  
 Stainless Flush Door Cabinets, Bi-Fold Door Cabinets..... 5

**Cabinets**

Heavy Duty, See-Thru Cabinets..... 6  
 Narrow, Double Door, Center Partitions..... 7  
 Super Heavy Duty, Bi-Fold Door Cabinets..... 8  
 Gas Cylinder, Bookshelf, Counter-Height Cabinets ..... 9  
 Flush Door & Pocket Door Bin Cabinets .....10-11  
 Wardrobes, Locker Style Cabinets, Personal Locker.....12  
 Personal Lockers, Athletic Lockers.....13  
 Drawer, File Drawer, and Door Cabinets .....14  
 Wall & Bench Cabinets..... 15  
 Standing & Mobile Shop Desks..... 16  
 File Cabinet Desk, Shop & Shop Cabinet Desks .....17  
 Computer Enclosure, Cart & Table, Cabinet Drawer..... 18

**Benches**

Sliding Door Workbenches..... 19  
 Base Cabinet & Drawer Benches..... 20  
 Shop Cabinets, Drawer Base Benches..... 21  
 Drop Front Benches, Hydraulic Lift Table ..... 22  
 Coolant Top Benches ..... 23  
 Mobile Cabinet Workbenches..... 24  
 Portable Maintenance Centers & Tool Cabinets ..... 25  
 Portable Door & Drawer Cabinets ..... 26-27  
 Heavy & Extra Heavy Duty Work Tables..... 28  
 Mobile Tables, Utility Tables, Assembly Stools ..... 29  
 All Welded Workbenches ..... 30-31  
 Knock Down Workbenches ..... 32  
 Ergonomic Hydraulic Workbenches ..... 33  
 Work Stations..... 34  
 Welding Benches..... 35  
 Versatile Modular Workbenches & Accessories ..... 36-37  
 Workbench Accessories..... 38-39

**Carts & Tables**

Utility Tables & Carts..... 40  
 Hopper & Pull Carts, Welded Box Trucks .....41  
 Stock Carts, Slat Top Trucks..... 42  
 Heavy & Extra Heavy Duty Shop Trucks..... 43  
 Single & Double End Trucks, Ladder Stock Carts ..... 44  
 Instrument, Tote-All, and Pan & Tray Trucks ..... 45  
 Five Shelf Carts & Trucks ..... 46  
 Three Sided Carts & Trucks ..... 47  
 Shelf & Garment Trucks..... 48  
 Dump & Box Trucks ..... 49  
 Platform Trucks..... 50-51  
 Lumber Trucks, Sheet & Panel, Specialty Carts ..... 52  
 Bar, Rod, & Cradle Trucks ..... 53  
 A-Frame Trucks & Accessories.....54-55  
 Portable Bin & Shelf Carts, Storage Bins ..... 56

**Caster Shoes & Casters**

Caster Shoes & Casters..... 57

**Drum & Can Handling**

Drum Storage Racks & Cradles ..... 58  
 Drum & Can Dollies, Drum Dolly Trucks ..... 59  
 Drum Lifters, Grips & Hooks ..... 60

**Hand Trucks**

All Purpose, Gas Cylinder, & Beverage Trucks ..... 61

**Racks & Storage**

Rack-U-Frames, Stacking Rack Units & Vertical Bar ..... 62  
 Bin Cabinet, Knock Down Shelving, Racks ..... 63  
 Bin Shelving Racks ..... 64  
 Shelving Racks, Bin Cabinets ..... 65  
  
 Model Listings ..... 66

**Purol Powder Coat Finishes**

**Industrial Finish-** 13 standard colors are available in addition to an infinite number of custom colors. Just send us a swatch or sample and we'll match it. All equipment is finished in an electrostatically applied powder coat finish.

**Purol Construction**

**All Welded Construction -** With exception to our knock-down benches and some shelving, all Purol Equipment is shipped ready to use of all welded construction. Welds mean no bolts or fasteners to loosen and create down time or unsafe conditions. We use MIG, TIG, and resistance welding done by experienced welders.



TU-SS-1925-2



TU-SS-1925-2-C5



TU-SS-1925-3-C5



SC-SS-1836-3-C5



SCF-SS-1836-2-C5

**TU-SS Series** - All utility tables and carts are constructed of 16 gauge, type 304, #4 stainless steel. Units have a choice of floor pads or 5" x 1 1/4" polyurethane casters and come with 2 or 3 shelves. Shelves include side & backstops to prevent items from rolling off.

**SC & SCF-SS Series** - All stock carts are constructed of 16 gauge, type 304, #4 stainless steel. Units can be ordered with 2 or 3 shelves with a tray or flat top. All trays are 2 1/2" deep.

**TU-SS Series - Stainless Utility Carts & Tables**

Model	W	H	L	Shelves	Wt.
TU-SS-1323-2	13"	34"	23"	2	25
TU-SS-1925-2	19"	34"	25"	2	32
TU-SS-1925-3	19"	34"	25"	3	42
TU-SS-2324-2	23"	34"	24"	2	35
TU-SS-2324-3	23"	34"	24"	3	46
TU-SS-2028-2	20"	34"	28"	2	35
TU-SS-2028-3	20"	34"	28"	3	47
TU-SS-2436-2	24"	34"	36"	2	49
TU-SS-2436-3	24"	34"	36"	3	67

**SC-SS Series - Stainless Steel Stock Carts**

Model	W	H	L	Shelves	Wt.
SC-SS-1828-2-C5	18"	36"	28"	2	52
SC-SS-1828-3-C5	18"	36"	28"	3	66
SCF-SS-1836-2-C5	18"	36"	36"	2	58
SC-SS-1836-3-C5	18"	36"	36"	3	76
SC-SS-2436-2-C5	24"	36"	36"	2	68
SC-SS-2436-3-C5	24"	36"	36"	3	90
SCF-SS-1828-2-C5	18"	36"	28"	2	52
SCF-SS-1828-3-C5	18"	36"	28"	3	66
SCF-SS-1836-2-C5	18"	36"	36"	2	58
SCF-SS-1836-3-C5	18"	36"	36"	3	76
SCF-SS-2436-2-C5	24"	36"	36"	2	68
SCF-SS-2436-3-C5	24"	36"	36"	3	90





**HDSC-SS-3678-18-4**



**BDSC-SS-3678-18-L**

• Shown with optional 6" legs

• Shown with optional 6" legs

**BDSC-SS-3678-18BL**

**Stainless Steel Flush Door Cabinets**

Model	Shelves	W	H	D	Wt.
HDSC-SS-3678-18-4	1 Fixed, 3 Adj	36"	78"	18"	264
HDSC-SS-3678-24-4	1 Fixed, 3 Adj.	36"	78"	24"	307
HDSC-SS-18-Shelf		36"		18"	13
HDSC-SS-24-Shelf		36"		24"	17

These flush door cabinets in type 304, #4 stainless steel finish feature welded 16 gauge construction. Both models include 3 adjustable shelves and 1 fixed shelf and come with a keyed handle. Options include: Extra shelves. Use suffix (-L) for optional 6"H legs.

**Stainless Steel Bi-Fold Door Cabinets**

Model	Shelves	Bins	W	H	D	Wt.
BDSC-SS-3678-18	1 Fixed, 3 Adj.	-	36"	78"	18"	265
BDSC-SS-3678-24	1 Fixed, 3 Adj.	-	36"	78"	24"	305
BDSC-SS-3678-18B	1 Fixed	24	36"	78"	18"	297
BDSC-SS-3678-24B	1 Fixed	24	36"	78"	24"	337
BD-SS-18-Shelf			36"		18"	13
BD-SS-24-Shelf			36"		24"	17

These Bi-Fold door cabinets in type 304, #4 stainless steel finish feature welded, heavy duty construction and include a 3-point locking mechanism with a built-in cylinder lock and 2 keys. Standard units include 3 adjustable and 1 fixed shelf. Suffix (-B) comes equipped with 16 each 14 X 8 X 7 and 8 each 14 x 16 x 7 storage bins and include 1 fixed shelf. Options: Extra shelves, 6"H legs (suffix -L)

# Heavy Duty Storage Cabinets

CABINETS



**HDSC-3678-24-4**

Also Available in Type 304  
Stainless Steel  
(HDSC-3678-18 & HDSC-3678-24)  
See Pg. 5

## HDSC Series - Heavy Duty Storage Cabinets

Model	W	H	D	Shelves	Wt.
HDSC-3648-19-2	36"	48"	19"	2	205
HDSC-3660-19-3	36"	60"	19"	3	250
HDSC-3672-19-4	36"	72"	19"	4	300
HDSC-3678-19-4	36"	78"	19"	4	318
HDSC-3684-19-4	36"	84"	19"	4	336
HDSC-3648-24-2	36"	48"	24"	2	220
HDSC-3660-24-3	36"	60"	24"	3	282
HDSC-3672-24-4	36"	72"	24"	4	346
HDSC-3678-24-4	36"	78"	24"	4	364
HDSC-3684-24-4	36"	84"	24"	4	382
HDSC-4848-19-2	48"	48"	19"	2	230
HDSC-4860-19-3	48"	60"	19"	3	286
HDSC-4872-19-4	48"	72"	19"	4	343
HDSC-4878-19-4	48"	78"	19"	4	360
HDSC-4884-19-4	48"	84"	19"	4	378
HDSC-4848-24-2	48"	48"	24"	2	268
HDSC-4860-24-3	48"	60"	24"	3	333
HDSC-4872-24-4	48"	72"	24"	4	399
HDSC-4878-24-4	48"	78"	24"	4	416
HDSC-4884-24-4	48"	84"	24"	4	436

**HDSC Series** - Each unit is constructed of 12 gauge sides, 14 gauge reinforced shelves and bottom. Cabinets available 19" or 24" deep, 36" or 48" wide. All models include one fixed shelf. All other shelves are adjustable on 4" centers. Keyed handle included. Also available with perforated or clear acrylic panel doors. Indicate by adding suffix (-perf or -plex), see below.

■ **Capacity:** \*1,500 lbs. per shelf. The HDSC series shelves have been tested at 3,000 lbs. per shelf evenly distributed.

■ **Options:** Extra shelves, 5" casters, 6"H legs, suffix (-L).



**HDSC-3678-19-4-PLEX**

**HDSC-PLEX Series See Thru Cabinets** - Available in same sizes and configurations as HDSC series (see above).

■ **Capacity:** 1,500 lbs. per shelf.

■ **Options:** Extra shelves, 5" casters, 6"H legs, suffix (-L).

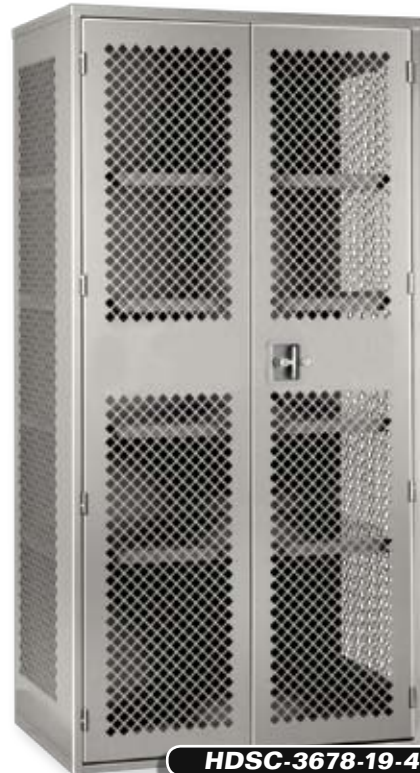

**HDSC-3678-19-4-PERF**

**HDSC-PERF Series Perforated Cabinets** - Available in same sizes and configurations as HDSC series (see above).

■ **Capacity:** 1,500 lbs. per shelf.

■ **Options:** Extra shelves, 5" casters, 6"H legs, suffix (-L).



**HDSC-1872-24-4**



**HDSC-3672-24-4-DD**



**HDSC-3672-24-8-CP**

**HDSC Narrow Series** - Features 4 adjustable shelves. Constructed from the same heavy duty materials as our HDSC series.  
 ■ **Capacity:** 1,500 lbs. per shelf. ■ **Options:** Extra shelves, 6"H legs, suffix (-L).

**HDSC-DD Double Door Series** - Unique design allows cabinet to be accessed from both sides.  
 ■ **Capacity:** 1,000 lbs. per shelf. ■ **Options:** Extra shelves, 6"H legs, suffix (-L).

**HDSC-CP Center Partition Series** - 2 separate lockable doors and a center partition which provide 2 lockable sections.  
 ■ **Capacity:** 1,000 lbs. per shelf. ■ **Options:** Extra shelves, 6"H legs, suffix (-L).

**HDSC-Narrow - Heavy Duty Cabinets**

Model	W	H	D	Shelves	Wt.
HDSC-1860-24-4	18"	60"	24"	4	210
HDSC-1872-24-4	18"	72"	24"	4	240

**HDSC-DD - Double Door Cabinets**

Model	W	H	D	Shelves	Wt.
HDSC-3672-19-4-DD	36"	72"	19"	4	320
HDSC-3672-24-4-DD	36"	72"	24"	4	368
HDSC-4872-19-4-DD	48"	72"	19"	4	362
HDSC-4872-24-4-DD	48"	72"	24"	4	418

**HDSC-CP - 2 Door Center Partition Cabinets**

Model	W	H	D	Shelves	Wt.
HDSC-3672-19-8-CP	36"	72"	19"	8	360
HDSC-3672-24-8-CP	36"	72"	24"	8	418
HDSC-4872-19-8-CP	48"	72"	19"	8	403
HDSC-4872-24-8-CP	48"	72"	24"	8	472

**HDSC D Series** - Features 2 adjustable shelves on 4" centers. Constructed from the same materials as our HDSC series. Includes keyed handle with 3 point locking system and 6" H legs.

■ **Capacity:** 1,500 lbs. per shelf, 250 lbs. per drawer  
 ■ **Options:** Extra shelves.

**HDSC-D - Heavy Duty Cabinets w/Drawers**

Model	W	H	D	Drwrs.	Wt.
HDSC-3672-24-2-3D	36"	78"	24"	3	510
HDSC-4872-24-2-6D	36"	78"	24"	6	605
HDSC-6072-24-2-9D	48"	78"	24"	9	710



**HDSC-4872-24-2-6D**

**Super Heavy Duty Cabinets**

**2,000 LB  
PER SHELF  
CAPACITY**



**SXHDSC-4872-24-4**

**SXHDSC Series - Super Heavy Duty Cabinets**

Model	W	OAH	D	Shelves	Wt.
SXHDSC-3648-24-2	36"	54"	24"	2	339
SXHDSC-3660-24-3	36"	66"	24"	3	391
SXHDSC-3672-24-4	36"	78"	24"	4	460
SXHDSC-3672-20-4	36"	78"	20"	4	419
SXHDSC-4860-24-3	48"	66"	24"	3	473
SXHDSC-4872-24-4	48"	78"	24"	4	558
SXHDSC-6060-24-3	60"	66"	24"	3	580
SXHDSC-6072-24-4	60"	78"	24"	4	686
SXHDSC-7260-24-3	72"	66"	24"	3	694
SXHDSC-7272-24-4	72"	78"	24"	4	734
SXHDSC-3672-24-2-3D	36"	78"	24"	2	636
SXHDSC-4872-24-2-6D	48"	78"	24"	2	764
SXHDSC-6072-24-2-9D	60"	78"	24"	2	912



**SXHDSC-3672-24-2-3-D**



**Durable Cast Handle**



**Super Duty Hinges**

**SXHDSC Series** - Superior 12 gauge steel construction supports loads up to 2,000 lbs. per shelf, evenly distributed. Shelves adjust on 4" centers. Durable cast handle with padlock tab combined with locking rod assembly provides maximum security. Cabinet includes 6" legs. Constructed with super duty welded hinges. -D units include drawers.  
**Options:** Extra shelves.

**Bi-Fold Door Cabinets**

**BDSC Series - Bi-Fold Door Cabinets**

Model	W	H	D	Shelves	Wt.
BDSC-3678-18-4	36"	78"	18"	4	215
BDSC-3678-24-4	36"	78"	24"	4	250
BDSC-3678-18-B	36"	78"	18"	1	225
BDSC-3678-24-B	36"	78"	24"	1	260

**BDSC Series** - Cabinet has bi-fold doors that project only 9" when open. Doors have a 3-point lock mechanism with a built-in cylinder lock and 2 keys. All welded, fully assembled. Features 3 adjustable and 1 fixed shelf. BDSC-3678-18-B and BDSC-3678-24-B come equipped with 16 each 14"x 8"x 7" and 8 each 14"x 16"x 7" storage bins.  
**Options:** Extra shelves, 6"H legs, suffix (-L).

**Also Available in Type 304  
Stainless Steel**  
See Pg. 5



**BDSC-3678-18-B**



**BDSC-3678-18-4**





**Gas Cylinder Cabinets**



**UGCSC-16**



**GCSC-16**

**UGCSC & GCSC Series** - Store flammables, LP gas cylinders for plant safety. Expanded metal open air design, protects cylinders. Hinged lockable doors prevent tampering and theft. Complete with safety signs. Safety yellow finish unless otherwise specified.

**UGCSC Series - Vertical Cylinder Cabinets**

Model	W	H	D	Capacity	Wt.
UGCSC-8	30"	72"	38"	8 Cyl.	187
UGCSC-16	60"	72"	38"	16 Cyl.	365

**GCSC Series - Horizontal Cylinder Cabinets**

Model	W	H	D	Capacity	Wt.
GCSC-4	30"	42"	38"	4 Cyl.	206
GCSC-8	30"	72"	38"	8 Cyl.	272
GCSC-12	45"	72"	38"	12 Cyl.	338
GCSC-16	60"	72"	38"	16 Cyl.	505

**Book Shelf Cabinets**



**BSC-3675**

**BSC Bookshelf Cabinets** - Unit is constructed of heavy gauge steel. Top section equipped with two fixed shelves, 12" deep, for storage of books and catalogs. Cabinet below is 48" tall and has three fixed shelves, 19" deep with a clearance of 10". Furnished with keyed handle. 48" high from floor to top of storage cabinet.  
**■ Dimensions:** 19"D x 36"W x 75"H **■ Weight:** 235 lbs.

**Heavy Duty Counter Height Cabinets**



**HDTC-2442**



**HDTC-2442PD-L**

• Shown with optional 6" legs, in Pucel light blue

**HDTC Series - Counter Height Cabinets**

Model	W	H	D	Wt.
HDTC-2442	24"	42"	19"	122
HDTC-2442P	24"	42"	19"	115
HDTC-2442D	24"	42"	19"	145
HDTC-2442PD	24"	42"	19"	130

**HDTC Series - Counter Height Cabinets** - Units equipped with padlock hasp and keyed handle for extra security. 12 gauge top, bottom and door. 48" overall height with legs. P model includes a perforated door, D model is equipped with a 1416-1 drawer unit, and the PD model has a perforated door and drawer unit.  
**■ Options:** 6"H legs, suffix (-L).

**Flush Door Bin Cabinets**



**HDBC-4878-00-170 STYLE A**

**EXTRA  
HEAVY  
DUTY**



**HDBC-3672-40-96 STYLE B**



**HDBC-3672-26-64 STYLE C**

**PB Series Bins**

Bin #	D	W	H
PB1	5"	4"	3"
PB2	7"	4"	3"
PB3	11"	6"	5"
PB4	10"	8"	7"
PB5	14"	8"	7"
PB6	14"	16"	7"



**HDBC Series - Extra Heavy Duty Flush Door Bin Cabinets**

These tough cabinets are made from 14 gauge steel. All welded construction. Units have removable plastic bins with a front label holder for easy part identification. Doors equipped with keyed handle, two keys and a three point locking system for extra security.

■ **Options:** Extra bins, steel door shelves, extra shelves, 6"H legs, suffix (-L).

**HDBC Series - Heavy Duty Flush Door Storage Bin Cabinets**

Model	Style	Bin Quantity						Shelves		W	D	H	Wt.
		PB1	PB2	PB3	PB4	PB5	PB6	Cab.	Door				
HDBC-3672-00-132	A	48	48	18	12	6	-	-	-	36"	24"	72"	316
HDBC-4878-00-170	A	64	64	24	12	6	-	-	-	48"	24"	78"	525
HDBC-6084-00-227	A	80	90	30	18	9	-	-	-	60"	24"	84"	613
HDBC-3672-40-96	B	48	48	-	-	-	-	4	-	36"	24"	72"	351
HDBC-4878-40-128	B	64	64	-	-	-	-	4	-	48"	24"	78"	527
HDBC-6084-40-170	B	80	90	-	-	-	-	4	-	60"	24"	84"	656
HDBC-3672-26-64	C	-	48	-	-	16	-	2	6	36"	24"	72"	345
HDBC-4878-26-84	C	-	64	-	-	20	-	2	6	48"	24"	78"	514
HDBC-6084-26-185	C	80	90	-	-	6	9	2	6	60"	24"	84"	650

## Pocket Door Bin Cabinets

# CABINETS • BIN



**PDBC-4872-00-170 STYLE A**

**HEAVY  
DUTY**



**PDBC-4872-40-128 STYLE B**



**PDBC-4872-26-84 STYLE C**

### PDBC Series - Heavy Duty Pocket Door Bin Cabinets

These units are constructed of 16 gauge steel with leveling glides. All models accept adjustable shelves. Unique high security hasp accepts padlock. Bins hang on mounting panels welded to cabinet back and doors. All cabinets accept shelves on 4" centers.

■ **Options:** Extra bins, steel door shelves, extra shelves, 6"H legs, suffix (-L)



### PDBC Series - Heavy Duty Pocket Door Storage Bin Cabinets

Model	Style	Bin Quantity						Shelves		W	D	H	Wt.
		PB1	PB2	PB3	PB4	PB5	PB6	Cab.	Door				
PDBC-3872-00-132	A	48	48	18	12	6	-	-	-	38"	24"	72"	367
PDBC-4872-00-170	A	64	64	24	12	6	-	-	-	48"	24"	72"	423
PDBC-6072-00-227	A	80	90	30	18	9	-	-	-	60"	24"	72"	525
PDBC-3872-40-96	B	48	48	-	-	-	-	4	-	38"	24"	72"	431
PDBC-4872-40-128	B	64	64	-	-	-	-	4	-	48"	24"	72"	499
PDBC-6072-40-170	B	80	90	-	-	-	-	4	-	60"	24"	72"	625
PDBC-3872-26-64	C	-	48	-	-	16	-	2	6	38"	24"	72"	411
PDBC-4872-26-84	C	-	64	-	-	20	-	2	6	48"	24"	72"	473
PDBC-6072-26-185	C	80	90	-	-	6	9	2	6	60"	24"	72"	587

Call Us Toll Free At 1-800-336-4986 for a Distributor Near You

**Wardrobes & Locker Style Cabinets**

**WSC Series - Wardrobe Storage Cabinets**

Model	Shlvs.	Drawers	W	H	D	Wt.
WSC-3672-24	5	-	36"	72"	24"	290
WSC-3672-24-4D	3	4	36"	72"	24"	419
WSC-4872-24-4D	3	4	48"	72"	24"	460
WSC-6072-24-4D	3	4	60"	72"	24"	501
WSC-3672-24-3D	3	3	36"	72"	24"	419
WSC-4872-24-3D	3	3	48"	72"	24"	460
WSC-6072-24-3D	3	3	60"	72"	24"	501

**WSC Series - Wardrobe Cabinets-** These extra heavy duty wardrobe storage cabinets are constructed from the same heavy duty materials as our HDSC series. Each unit includes a keyed handle, a top shelf, and a coat rod. The (-4D) units below are equipped with a 1416-4 recessed handle drawer unit that offers a capacity of 100 lbs. per drawer. The (-3D) units include 3 half fixed shelves and 3 drawers that offer a 250 lb. capacity per drawer. Each drawer opens with a telescoping full extension slide. Overall height with legs, 78".

■ **Options:** Padlock hasp, 6"H legs.



**WSC-3672-24-4DL**



• Shown with optional 6" legs



**WSC-3672-24**



**DLCU-2424-1**



**DLCU-2424-2**

**DLCU-2424-3**

**DLCU Series Locker Style Cabinets** - Doors equipped with pull handle and padlock loop. The entire unit is all welded, constructed of 14 gauge steel.  
 ■ **Dimensions:** 24"W x 24"D x 74"H. ■ **Options:** Keyed handle, comb. lock.

**DLCU Series - Heavy Duty Locker Style Cabinets**

Model	Doors	Compts.	Compartment Size			Wt.
			W	D	H	
DLCU-2424-1	1	3	23½"	24"	22½"	228
DLCU-2424-2	2	2	23½"	24"	34½"	215
DLCU-2424-3	3	3	23½"	24"	22½"	230



**DPL-1621**

**DPL Lockers** - Each stackable locker section comes equipped with three fixed shelves, padlock loop eye, and keyed handle. Shelf clearances: 5" top shelf to first shelf; 5" first to second shelf; 4¼" second to third shelf; 10 ½" third shelf to bottom.

■ **Dimensions:** Top locker: 21" W x 16" D x 34" H. Bottom locker: 21" W x 16" D x 30" H

■ **Weight:** Top section: 85 lbs, bottom section: 89 lbs.

# Steel Lockers

CABINETS • LOCKERS



**STL-1212-72**



**DTL-1212-72**



**MTL-1212-72**

### STL Series - Single Tier Lockers

Model	W	D	H	Wt.
STL-1212-60	12"	12"	60"	62
STL-1218-60	12"	18"	60"	75
STL-1212-72	12"	12"	72"	71
STL-1218-72	12"	18"	72"	86
STL-1818-72	18"	18"	72"	105

### DTL Series - Double Tier Lockers

Model	W	D	H	Wt.
DTL-1212-60	12"	12"	60"	62
DTL-1218-60	12"	18"	60"	75
DTL-1212-72	12"	12"	72"	71
DTL-1218-72	12"	18"	72"	86
DTL-1818-72	18"	18"	72"	105

### MTL Series - Multi Tier Lockers

Model	W	D	H	Wt.
MTL-1212-60	12"	12"	60"	73
MTL-1218-60	12"	18"	60"	90
MTL-1212-72	12"	12"	72"	84
MTL-1218-72	12"	18"	72"	104
MTL-1818-72	18"	18"	72"	130

**STL, DTL & MTL Series Lockers** - All steel lockers are welded and fully assembled. Single tier unit has a shelf 10" from top and includes coat rod, 1 two prong hook and 2 one prong coat hooks. Double tier has 1 two prong hook and 2 one prong hooks. MTL lockers have all open compartments. Doors have padlock loop with chrome handle. Louvers on front door. Holes in sides provided for bolting multiple units together. For overall height, add 6".



**PL-1875**

**PL Personal Lockers** - Heavy duty, all welded steel locker. Slope top single door locker 18"W x 18"D x 75" OAH. Unit has a 3" high base. Equipped with shelf, hanger bar, rear coat hooks. Features recessed cylinder lock paddle handle. Louvers on door for ventilation.  
**■ Dimensions:** 18" W x 18" D x 75" overall height.  
**■ Weight:** 175 lbs.



**GL-2472-24-DFL**



**GL-2472-24-FL**

**GL Series** - Athletic Gear Lockers include a full width coat rod, 2 coat hooks, top compartment with padlock hasp, 14"H perforated, lockable foot locker compartment and 4" H legs.  
 -FL models feature a doorless open design,  
 -DFL has a 24" W perforated door.

### GL Series - Athletic Gear Lockers

Model	D	W	H	Wt.
GL-2472-18-FL	18"	24"	76"	145
GL-2472-18-DFL	18"	24"	76"	157
GL-2472-24-FL	24"	24"	76"	180
GL-2472-24-DFL	24"	24"	76"	192

• Shown in Pucel light blue

Call Us Toll Free At 1-800-336-4986 for a Distributor Near You

**Drawer Cabinets**



**DC-1**



**DC-1 & #6 Base**



**DC-1C5**

**DC-1 Drawer Cabinets** - Drawers slide on telescoping ball bearing steel slides. Each drawer includes a sliding tray, which holds small items within easy reach. Individual drawer size 14"W x 23½" D x 5" H.

■ **Dimensions:** 18" W x 24" D x 26" H (32" H with base or 5" casters). ■ **Weight:** 110 lbs. (120 lbs. with base or casters).

■ **Casters:** DC-1C includes 4 swivel 3" hard rubber or 5" polyurethane casters.

■ **Options:** Extra shelves, cylinder locks.



**DCF-1**



**DCF-1 & #6 Base**



**DCF-1C5**

**DCF-1 File Drawer Cabinets** - All drawers feature telescoping ball bearing slides. Each drawer includes a sliding tray to hold small items. Larger lower drawer can be used as a file drawer. Upper drawer size 14"W x 23½" D x 5" H.

■ **Dimensions:** 18" W x 24" D x 26" H (32" H with base or 5" casters) ■ **Weight:** 105 lbs. (115 lbs. with base or casters).

■ **Casters:** DCF-1C includes 4 swivel, 3" hard rubber or 5" polyurethane casters. ■ **Options:** Cylinder locks.

**Door Cabinets**



**BC-1**



**BC-1 & #6 Base**



**BC-1C5**

**BC-1 Series Door Cabinet** - This door cabinet includes one shelf, adjustable on 4" centers, keyed handle.

■ **Dimensions:** 18" W x 24" D x 26" H (32" H with base or 5" casters). ■ **Weight:** 55 lbs. (65 lbs. with base or casters)

■ **Casters:** BC-1C includes 4 swivel, 3" hard rubber or 5" polyurethane casters. ■ **Options:** Extra shelves.

## Wall & Bench Cabinets



**WBC-2630-6**



**WBC-2630-B**

### WBC Series - Wall & Bench Cabinets

Model	Shelves	W	D	H	Wt.
WBC-2621-4	4	26½"	9"	21"	39
WBC-2630-6	6	26½"	9"	30"	53
WBC-2630-3	3	26½"	9"	30"	44
WBC-3524-2	2	35½"	9"	24"	45

### WBC-B - Wall & Bench Bin Cabinet

Model	Shelves	Bins	W	D	H	Wt.
WBC-2630-B	1	24	26½"	9"	30"	55

**WBC Series Cabinets-** All welded 20 gauge cabinets keep small parts organized and out of the way. Can be mounted on a wall or bench. Doors are secured with a cylinder lock (2 keys included).

**WBC-B Wall & Bench Bin Cabinet-** These 20 gauge welded cabinets keep small parts organized and out of the way. Featuring 16 gauge louvered back panel. Cabinet can be mounted on a wall or bench. Doors are secured with a cylinder lock (2 keys included).

## Wall Cabinets



**WC-3027**



**WC-3627-B**

### WC Series - Wall Cabinets

Model	W	D	H	Wt.
WC-3027	30"	14"	27"	60
WC-3627	36"	14"	27"	68
WC-4827	48"	14"	27"	88

### WC Series - Wall Bin Cabinets

Model	Bins	W	D	H	Wt.
WC-3627-B	24	36"	14"	27"	82
WC-4827-B	32	48"	14"	27"	122



**WC-4827-B**

**WC Series Cabinets-** Extra heavy duty 18 gauge all welded steel cabinets. Can be mounted on a wall. Flush mount double doors with 2-point locking handle. Includes one adjustable shelf.

■ **Options:** Extra shelves, extra bins.

**Shop Desks**



• Shown with optional P-66, in Pucel light blue

**1236**



**1036**

**1436**

**1836**

• Shown with optional casters

**1036 - 1836 Series Shop Desks** - Open body desk. 1236 through 1836 models include drawers with small parts trays. All drawers have telescoping ball bearing steel slides.

■ **Dimensions:** 36" W x 30" D x 43" H. Overall height 48"  
 ■ **Options:** Casters, cylinder locks, pigeon hole units & risers.

**Standing Shop Desks**

Model	Drawers	Drw. W	D	H	Wt.
1036	NA	NA	NA	NA	85
1236	2	14"	16"	5"	115
1436	4	20"	24"	5"	225
1836	8	14"	24"	5"	325
R-36	Riser Shelf				15
P-36	Pigeon Hole Unit (3 Comp.)				15
P-66	Pigeon Hole Unit (6 Comp.)				24

**Extra Wide Shop Desks**



• Shown with optional riser shelf

**1248**

**1248 Extra Wide Shop Desk** - Open body, heavy duty desk provides more working space than regular shop desks. Steel 14 gauge top, 18½" x 48" lower shelf. Includes two 14" W x 16" D x 5" H full extension drawers. Drawers feature telescoping ball bearing steel slides.

■ **Dimensions:** 48" W x 30" D x 43" H. ■ **Weight:** 128 lbs.  
 ■ **Options:** Cylinder locks, pigeon hole units, risers, casters.

**Mobile Shop Desks**



**OSD-2023**

**ESD-2023**

**OSD & ESD Mobile Shop Desks** - Mobile heavy duty desks provides organized and secure storage. Cylinder locking drawers measure 21" W x 19 ¼" D x 5" H. with telescoping ball bearing steel slides. Writing surface includes retaining lip and is 42" High at front, 44" at back. ■ **Casters:** OSD equipped with 4 swivel, 3" soft rubber casters. ESD comes with 5 " polyurethane casters (2 rigid, 2 swivel). ■ **Dimensions:** 23" W x 20" D x 51" H. ■ **Weight:** OSD-2023 82 lbs., ESD-2023 154 lbs.



**Shop Desks**



**FCD-2839**

**FCD 2839 Shop Desk** - Unique multi-purpose desk features standard three drawer letter size locking filing cabinet on right side. Locking desk drawer. Convenient 24" W x 20" D bottom shelf. Clear acrylic over desk top. Includes pigeon hole unit.  
 ■ **Dimensions:** 39" W x 28" D x 53½" H; 42" H to work surface.  
 ■ **Weight:** 275 lbs.

**FULL EXTENSION DRAWER SLIDES**



**SD-2860**

**SD-2860 Shop Desk** - All welded, heavy gauge steel desk. Equipped with steel top, double pedestal, six spacious drawers, and cylinder locks. Drawers slide on ball bearing steel slides. Features dividers and shelves for computer monitor, books etc.  
 ■ **Dimensions:** 60"W x 28"D x 52"OAH. ■ **Weight:** 295 lbs.

**Shop Cabinet Desks**



**3236**

• Shown with optional P-36



**2036**

• Shown in Pucel red

**Shop Cabinet Desks**

Model	Drawers	Shelves	Wt.
2036	NA	2	184
2136	1	2	202
2236	2	2	219
3036	NA	3	205
3136	1	3	222
3236	2	3	240
P-36	Pigeon Hole Unit (3 Comp.)		15
P-66	Pigeon Hole Unit (6 Comp.)		24

**Shop Cabinet Desks** - Constructed of 14 gauge steel top and sides. These enclosed body desks come complete with doors and shelves. Some models include drawers. Comes with keyed handle.  
 ■ **Dimensions:** 36"W x 30"D x 43"H. Overall height 48"  
 ■ **Options:** Cylinder locks, pigeon hole and riser units.



**Computer Enclosures**



**SCW-3060**

**LPAS Series Low Portable Cart/ Stool** - Convenient 14" high, 1" tray bottom shelf. 3" soft rubber casters. Perfect for small technical equipment and supplies.

- **Dimensions:**  
LPAS-1616: 16" W x 16" D x 14" H.  
LPAS-1323: 23" W x 13" D x 14" H.
- **Capacity:** 300 lbs.
- **Weight:**  
LPAS-1616 19 lbs. LPAS-1323 22 lbs.
- **Casters:** 4 swivel 3" casters.



**LPAS-1323**

**Mobile Desks**

**500 LB CAPACITY**



**PPET-2636**

**SCW - 3060 Computer Enclosure Cabinet** - Enclosed all steel work station protects equipment from many types of industrial environments. A clear plexiglass upper door with cylinder lock, keeps monitor clean and secure. Ventilated space for monitor and CPU. Features pull-out full extension ball bearing keyboard and lower shelf. Lower cabinet with cylinder lock has adjustable middle shelf. Computer equipment & monitor not included.

- **Dimensions:** 30" W x 26" D x 60" H.
- **Weight:** 275 lbs. ■ **Options:** Casters, fan kit.

**PPET Portable Table** - Equipped with removable 1/4" pressed wood top and a 1/4" lip in front to prevent items from falling off. Unit has 8" high steel clipboard holder with a 70 degree slope to the back. Size 36"W x 26"D x 38 1/4"H front; 46 3/4"H back.

- **Dimensions:** 36" W x 26" D x 38 1/4" H frt. 46 3/4" H back
- **Capacity:** 500 lbs. ■ **Weight:** 63 lbs.
- **Casters:** 4 swivel 5" x 1" soft rubber casters.



**Cabinet Drawer Bench**



**W-3060-CD w/Hardwood Top**



**FULL EXTENSION DRAWER GLIDES**

**LW-3060-CD w/ Laminate Top**

**W-3060 Series Benches -**

This bench provides a large working space with large storage area. There are three 1424-1 drawers mounted side by side with cylinder locks. Cabinet has two doors, a keyed handle with one fixed shelf, which is centered. Hardwood top 30" x 60" x 1 3/4". ■ **Dimensions:** 60" W x 30" D x 34" H ■ **Weight:** 310 lbs. ■ **Options:** Steel, composition or laminate top, side & back stops.



**Basic + Door & Shelf**



**Laminate Top**



**Composite Top**



**Hard Wood Top**



**Basic + Door**



**Basic + Shelf**



**Basic**



**Basic**

Model	Top	D	W	Wt.
CS-2860	Steel	28"	60"	204
CS-2872	Steel	28"	72"	234
CW-3060	Wood	30"	60"	220
CW-3072	Wood	30"	72"	254

**Basic + Door**

Model	Top	D	W	Wt.
CS-2860-D	Steel	28"	60"	248
CS-2872-D	Steel	28"	72"	286
CW-3060-D	Wood	30"	60"	264
CW-3072-D	Wood	30"	72"	306

**Basic + Shelf**

Model	Top	D	W	Wt.
CS-2860-S	Steel	28"	60"	239
CS-2872-S	Steel	28"	72"	274
CW-3060-S	Wood	30"	60"	255
CW-3072-S	Wood	30"	72"	295

**Basic + Door & Shelf**

Model	Top	D	W	Wt.
CS-2860-SD	Steel	28"	60"	283
CS-2872-SD	Steel	28"	72"	326
CW-3060-SD	Wood	30"	60"	300
CW-3072-SD	Wood	30"	72"	346

**CW, CW-S, CW-D & CW-SD Series** - With or without sliding doors and/or shelves. Sliding doors are factory installed, equipped with cylinder lock and 2 keys. Shelves adjustable on 4" centers.

■ **Dimensions:** All bases 25" D x 34" H.

■ **Options:** Laminate or composition tops, side & back stops, extra shelves.

**Base Cabinet Benches**

FULL EXTENSION  
DRAWER GLIDES



**CDB-3060-W**



**FDB-3060-W**



**CB-3060-W**

**CDB Series - Drawer & Door Cabinets**

Model	Top	D	W	Wt.
CDB-2860-S	Steel	28"	60"	240
CDB-2872-S	Steel	28"	72"	275
CDB-3060-W	Wood	30"	60"	245
CDB-3072-W	Wood	30"	72"	280

**CB Series - Door Cabinets**

Model	Top	D	W	Wt.
CB-2860-S	Steel	28"	60"	205
CB-2872-S	Steel	28"	72"	230
CB-3060-W	Wood	30"	60"	210
CB-3072-W	Wood	30"	72"	235

**DB Series - Drawer Cabinets**

Model	Top	D	W	Wt.
DB-2860-S	Steel	28"	60"	300
DB-2872-S	Steel	28"	72"	320
DB-3060-W	Wood	30"	60"	305
DB-3072-W	Wood	30"	72"	325

**FDB Series - File & Drawer Cabinets**

Model	Top	D	W	Wt.
FDB-2860-S	Steel	28"	60"	300
FDB-2872-S	Steel	28"	72"	320
FDB-3060-W	Wood	30"	60"	305
FDB-3072-W	Wood	30"	72"	325

**CDB, CB & DB Series - Cabinet & Drawer Benches** - Four drawer and door units can be ordered in various combinations to form overall base. Drawer units are comprised of 20 gauge steel on full extension ball bearing steel slides. Equipped with padlock loop and small parts tray. Door cabinets include keyed handle and adjustable shelf. All models have factory installed No.6 base.

■ **Dimensions:** Drawers measure 14" W x 24" D x 5" H. Each base is 18" W x 24" D x 34" H  
 ■ **Options:** Laminate or composition top, side & back stops, cylinder locks, and extra shelves.



**DB-3060-W**



**Pucel's Standard Colors**

	Gray		Dark Blue
	Dark Green		Light Blue
	Vista Green		Orange
	Dark Brown		Red
	Beige		Putty
	Yellow		White
	Black		Custom Colors

# Heavy Duty Shop Cabinet Benches

BENCHES • CABINETS

**3,000 LB  
CAPACITY**



**C-2448**

**C Series - Shop Cabinets** - Heavy duty cabinet benches provide solid working surface. Units constructed of 12 gauge top, 14 gauge side leg panels. Two styles available, two shelves with one door, and one shelf with two doors. Comes standard with keyed handle, back and side stops.

■ **Dimensions:** 34" High to working surface. 37" overall height.  
 ■ **Capacity:** 3,000 lbs. ■ **Options:** Additional welded shelves.

### C Series - Shop Cabinet Benches

Model	Shelves	Doors	D	W	Wt.
C-1824	2	1	19"	24"	112
C-1836	1	2	19"	36"	140
C-1848	1	2	19"	48"	166
C-2436	1	2	25"	36"	160
C-2448	1	2	25"	48"	190



**C-1836**



**C-1824**

### Drawer Base Benches

**FULL EXTENSION  
DRAWER SLIDES**



**DBU-3072-W w/ Hardwood Top**



**DBU-2872-S w/VMW Series Options**

**DBU Series - Drawer Base Benches** - Features 16 drawers for maximum storage. Drawers are furnished with padlock loop. All drawers are equipped with full extensions ball bearing steel slides. There is a sliding 14" x 8" tray in each drawer to hold small items within easy reach.

■ **Dimensions:** DBU-3072-W (wood) 72" W x 30" D x 34" H; DBU-2872-S (steel) 72" W x 28" D x 34" H. Drawer size 14" W x 23½" D x 5" H.

■ **Weight:** 565 lbs. ■ **Options:** Options: steel, composition, or laminate top, cylinder locks in drawers.

**Tool & Repair Benches**

**3,000 LB  
CAPACITY**



**DFT-60-C**



**DFT-60**

**DFT Series Drop Front Benches** - Heavy duty construction allows for work on engines, pumps and any other repair items. Equipped with ball bearing, telescoping, full extension steel slides. Can also be used for mounting lathes, grinders, drill presses etc. DFT models are all equipped with drop front top. Designed for strength and appearance, convenient shelf 15¾" x 36". DFT-60 furnished with 2 1416-1 drawer units. DFT-60-C comes with 1 drawer unit and 1 CU-18 18" W x 19" D x 19" H cabinet. All drawers are 14" W x 16" D x 5" H.  
 ■ **Dimensions:** 22" W x 60" L x 32" H ■ **Weight:** DFT-60 198 lbs., DFT-60-C 238 lbs.  
 ■ **Capacity:** 3,000 lbs. ■ **Options:** Cylinder locks, keyed handle.

**Hydraulic Lift Top Table**



**HLTT-36-1**



**Pucel's Standard Colors**

	Gray		Dark Blue
	Dark Green		Light Blue
	Vista Green		Orange
	Dark Brown		Red
	Beige		Putty
	Yellow		White
	Black		Custom Colors

**HLTT - Hydraulic Lift Table** - Designed for moving dies & tools to and from work areas. The foot pedal easily adjusts the table height. Heavy, reinforced steel top. Floor lock holds the table firmly in place.  
 ■ **Dimensions:** 36" W x 20" D x 31" to 43" H.  
 ■ **Weight:** 260 lbs. ■ **Capacity:** 3,000 lbs.  
 ■ **Casters:** 2 swivel & 2 rigid 5" x 2" phenolic or semi-steel casters.  
 ■ **Options:** 5" x 2" Semi-steel or phenolic casters.



**CM-3630**

**3,000 LB  
CAPACITY**



**CF-2830**



**Optional - No.1015  
removable side shelf**



**Drain fitting  
standard with models  
CF, CM & CT**

**CM-Series - Drain Top Door Benches**

Model	D	W	H	Wt.
CM-2830	20"	28"	30"	95
CM-2835	20"	28"	35"	105
CM-3630	20"	36"	30"	115
CM-3635	20"	36"	35"	125

**CF Series - Basic Drain Top Benches**

Model	D	W	H	Wt.
CF-2830	20"	28"	30"	80
CF-2835	20"	28"	35"	86
CF-3630	20"	36"	30"	90
CF-3635	20"	36"	35"	96

**CF & CM Series** - Rugged drain top units with 1-1/8" tray fluid tops with 1/4" pipe connection. Equipped with 1/2" drain to handle fluids, lubricants, etc. Fabricated with floor lugs to secure base to floor. CF series complete with bottom shelf. CM Series comes with 1 door and keyed handle. CM Series are without shelves.

- **Capacity:** 3,000 lbs.
- **Options:** Cylinder locks in drawers, No. 1015 removable side shelf.



**CT-60**



**CT-2830**

**3,000 LB  
CAPACITY**

**CT Series - Fluid Top Drawer Benches**

Model	D	W	H	Wt.
CT-2830	20"	28"	30"	90
CT-2835	20"	28"	35"	96
CT-3630	20"	36"	30"	100
CT-3635	20"	36"	35"	106
CT-60	22"	60"	32"	198

**CT Series** - Specially designed cabinets for use in "Liquid" assembly and machining. Complete with 1-1/8" tray coolant tops with 1/2" pipe connection. A model for every purpose. Floor lugs to secure base to floor. Comes with 1 or 2 1416-1 drawers 14" W x 16" D x 5" H. All drawers equipped with stops, full extension ball bearing slides, and 1" deep small parts tray (see page 39).

- **Capacity:** 3,000 lbs.
- **Options:** Cylinder locks, No. 1015 removable side shelf.

**Mobile Cabinet Work Benches**

**4,000 LB  
CAPACITY**



MDCB-52 has four end mounted lockable drawers. Each glide smoothly on full extension ball bearing slides. Dimensions: 14½" W x 23½" D x 5" H.

**MDCB-52**



Both door and drawer cabinets offer additional storage space across the rear of the bench.



Both MDCB & MBCB models feature ultra-smooth riding casters.

**MBCB- 52 & MDCB-52 Series Mobile Benches -**

All-welded steel rolling bench has a heavy duty 14 gauge work surface. Locking tool box TB-9 has 9 drawers: two 21½" W x 3½" H, two 21½" W x 1¾" H, and four 6½" W x 1¾" H, and one central locking 6½" W x 3½" H drawer. Three rear 52" W x 8" D utility shelves add to storage space. Two swivel and two rigid 5" x 2" polyurethane casters for easy maneuverability on all floor surfaces.

- **Dimensions:** 52" W x 24" D x 36½" H.
- **Weight:** MBCB-52: 314 lbs., MDCB: 369 lbs.
- **Capacity:** 4,000 lbs.
- **Casters:** 2 swivel, 2 rigid 5" x 2" polyurethane casters.
- **Options:** Vise, floor lock.



**MBCB-52**

Tool chest with end mounted 18" W x 24" D lockable door cabinet Complete with adjustable shelf.

**Tool Box TB-9**



Nine smooth opening drawers on full extension slides.



Locking center hinged cover mechanism offers excellent security and slides away when not needed.

	Gray		Dark Blue
	Dark Green		Light Blue
	Vista Green		Orange
	Dark Brown		Red
	Beige		Putty
	Yellow		White
	Black		Custom Colors





**MDD 2448 - Mobile 3-Drawer & Door Cabinets**  
 Complete with 14" W x 16" D x 5" high drawers with individual cylinder locks and hinged door with locking handle. Comes with offset tubular pushbar, two rigid, two swivel roller bearing phenolic casters for easy maneuverability.  
 ■ **Dimensions:** 48" W x 24" D x 33" H  
 ■ **Weight:** 268 lbs.  
 ■ **Capacity:** 2,400 lbs.  
 ■ **Casters:** 2 swivel, 2 rigid 8" x 2" phenolic casters  
 ■ **Options:** Floor lock.

**MDD-2448**

**MTC-60 - Portable Maintenance Center Bench**  
 - Furnished with two 9 drawer TB-9 tool chests for the storage of tools, parts, and other items. Equipped with a keyed handle on the compartment doors and a cylinder lock on the tool cabinets for extra security. Overall length 64½".  
 ■ **Dimensions:** 60" W x 28" D x 38½" H for bench.  
 ■ **Weight:** 696 lbs. ■ **Capacity:** 4,000 lbs.  
 ■ **Casters:** 2 swivel, 2 rigid 8" x 2" phenolic casters.  
 ■ **Options:** Vise, floor lock, 3/16" steel plate top.



Tandem tool chests offer abundant tool storage with lockable drawers. Two large 25" W x 24" H x 14" D compartments with keyed handles for large item storage.

**MTC-60**

**Portable Tool Cabinets**



**PTC-48 - Portable Tool Cabinet Benches** - Furnished with a nine drawer TB-9 tool chest for the storage of tools, parts, and other items. Sides and back stops prevent objects from falling off work area. Equipped with vise shelf, keyed handle on the door. Cylinder lock on the tool chest for extra security. Overall dimensions 40¼" H x 63" L.  
 ■ **Dimensions:** 26" D x 48" W x 37 ¼" H  
 ■ **Weight:** 348 lbs. ■ **Capacity:** 2,000 lbs.  
 ■ **Casters:** 2 swivel, 2 rigid 8" x 2" phenolic casters.  
 ■ **Options:** 3/16" steel plate top, vise, floor lock.

**PTC-48**

**PC Series**



**PC-36**



**PC-48**



**PC-36-1424-1**



**PC-48-1424-1**



**PC-48-1424-4**



**PC-36-2-1424-1**



**PC-36-1424-4**

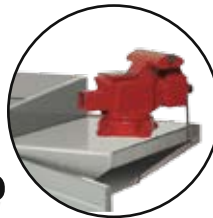

All PC models available with optional vise shelf & vise.

**PC Series - Mobile Cabinet Workbenches**

Model	D	W	H	Wt.
PC-36	26"	36"	34"	205
PC-36-1424-1	26"	36"	34"	273
PC-36-2-1424-1	26"	36"	34"	255
PC-36-1424-4	26"	36"	34"	315
PC-48	26"	48"	34"	247
PC-48-1424-1	26"	48"	34"	320
PC-48-1424-4	26"	48"	34"	357

**PC Series** - Available in seven configurations. All units include side and back stops, a keyed handle and a tubular push bar. ■ **Capacity:** 2,000 lbs.  
 ■ **Casters:** 2 swivel 2 rigid 5" x 2" phenolic or 5" x 2" semi-steel casters.  
 ■ **Options:** Floor lock, cylinder locks for drawers, vise shelf, vise.

**PUB Series**



**PUB-24-D**



**PUB-24-4DR**

**FULL EXTENSION  
DRAWER GLIDES**



**PUB-24**

• Shown in Pucel red

**PUB Series Portable Door & Drawer Cabinets** - Versatile mobile cabinets come standard with padlock loops and keyed handle in doors.

**PUB-24-D** Inside cabinet area 21-3/4" W x 20" D x 23-3/4" H.

**PUB-24-4DR** Features four 20" W x 19" D x 5" H drawers.

**PUB-24** One door with storage area of 20" W x 20" D x 13" H and two 20" W x 19" D x 5" H drawers.

■ **Weight:** PUB-24-D 80 lbs., PUB-24-4DR 134 lbs., PUB-24 138 lbs. ■ **Capacity:** 1,000 lbs.

■ **Casters:** 2 swivel, 2 rigid polyurethane or semi-steel casters. ■ **Options:** Cylinder lock drawers.

**Pegboard Option  
OP-1836**

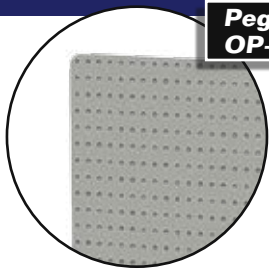

Louvered or steel  
pegboard back is  
available on all PDC  
series models



**PDC-36 w/ OL-1836**

**2,000 LB  
CAPACITY**

**1,000 LB  
CAPACITY**



**PDC-36**

**PDC-36 Series** - Equipped with four 20" W x 19" D x 5" H drawers on telescoping ball bearing slides. Each unit comes with separate cylinder locks in each drawer & keyed handle in door. Side & backstops prevent objects from falling off work area. Cabinet measures 12" wide x 26" high inside  
 ■ **Dimensions:** 36" W x 20 1/4" D x 34" H. ■ **Weight:** 168 lbs.  
 ■ **Capacity:** 2,000 lbs. ■ **Casters:** 2 swivel, 2 rigid 5" x 2" semi-steel or phenolic casters. ■ **Options:** Extra shelves, floor lock.



**PDC-36 w/ IL-1225**

**2,000 LB  
CAPACITY**



**PDC-46-4**

**PDC-46-4** Consists four 20" W x 19" D x 5" H drawers on telescoping ball bearing slides. Each unit comes with separate cylinder locks in all four drawers & keyed handle in door. Door cabinet has three shelves, 18" W x 19" D, shelf clearance is 8 1/4".  
 ■ **Dimensions:** 46" W x 21" D top, 34 1/2" H.  
 ■ **Weight:** 220 lbs. ■ **Capacity:** 2,000 lbs.  
 ■ **Casters:** 2 swivel, 2 rigid 5" x 2" semi-steel or phenolic casters.  
 ■ **Options:** Floor lock.



**PDC-46-8**

**PDC-46-8** Comprised of eight 20" W x 19" D x 5" H drawers on telescoping ball bearing slides. Each unit comes with separate cylinder locks and small parts tray in each drawers.  
 ■ **Dimensions:** 46" W x 21" D x 34 1/2" H.  
 ■ **Weight:** 220 lbs. ■ **Capacity:** 2,000 lbs.  
 ■ **Casters:** 2 swivel, 2 rigid 5" x 2" semi-steel or phenolic casters.  
 ■ **Options:** Floor lock.

**Heavy Duty Work Tables**

**2,000 LB  
CAPACITY**



**2872-2**



**2872-3**

**Extra Heavy Duty Work Tables**

**3,000 LB  
CAPACITY**



**HS-2872-2**



**HS-2872-3**

**Heavy Duty Work Tables**

Model	Shelves	Dpth.	Wdth.	Ht.	Wt.
1830-2	2	18"	30"	32½"	62
1830-3	3	18"	30"	32½"	85
1836-2	2	18"	36"	32½"	70
1836-3	3	18"	36"	32½"	98
1848-2	2	18"	48"	32½"	85
1848-3	3	18"	48"	32½"	120
1860-2	2	18"	60"	32½"	104
1860-3	3	18"	60"	32½"	148
2430-2	2	24"	30"	32½"	83
2430-3	3	24"	30"	32½"	112
2436-2	2	24"	36"	32½"	95
2436-3	3	24"	36"	32½"	130
2448-2	2	24"	48"	32½"	116
2448-3	3	24"	48"	32½"	162
2460-2	2	24"	60"	32½"	136
2460-3	3	24"	60"	32½"	192

**Heavy Duty Work Tables** - Versatile heavy duty stands handle large loads, machinery and assembly. Shelves are 12 ga. steel, 2" deep. Top shelf is flat, center and bottom are tray type. Drawers can be added (see pages 39).

■ **Dimensions:** Two shelf units provide 22¼" shelf clearance, three shelf units have 10-1/8" between shelves.

■ **Capacity:** 2,000 lbs. ■ **Options:** Drawer units, cylinder locks on drawers.



**HS Series - Extra Heavy Duty Work Tables**

Model	Shelves	Dpth.	Wdth.	Ht.	Wt.
HS-2448-2	2	24"	48"	36"	135
HS-2448-3	3	24"	48"	36"	185
HS-2460-2	2	24"	60"	36"	155
HS-2460-3	3	24"	60"	36"	215
HS-2472-2	2	24"	72"	36"	175
HS-2472-3	3	24"	72"	36"	245
HS-2848-2	2	28"	48"	36"	145
HS-2848-3	3	28"	48"	36"	205
HS-2860-2	2	28"	60"	36"	170
HS-2860-3	3	28"	60"	36"	240
HS-2872-2	2	28"	72"	36"	195
HS-2872-3	3	28"	72"	36"	275
HS-3448-2	2	34"	48"	36"	165
HS-3448-3	3	34"	48"	36"	230
HS-3460-2	2	34"	60"	36"	190
HS-3460-3	3	34"	60"	36"	280
HS-3472-2	2	34"	72"	36"	240
HS-3472-3	3	34"	72"	36"	335

**HS Series - Extra Heavy Duty Work Tables**

For handling extremely heavy load requirements. Available in sizes to 34" x 72", all shelves are flat. All models 36" high. Shelves are 12 gauge steel. 3/16" heavy-duty steel angle used. Drawer units can be added (see pages 38).

■ **Dimensions:** Two shelf models provide 23½" shelf clearance, three shelf units have 10 5/8" between shelves.

■ **Capacity:** 3,000 lbs. ■ **Options:** Drawer units, cylinder locks on drawers.

## Mobile Tables

### MT Series - Mobile Table

Model	Shelves	Dpth.	Wdth.	Ht.	Wt.
MT-2448-2	2	24"	48"	30"	100
MT-2448-3	3	24"	48"	30"	132
MT-2460-2	2	24"	60"	30"	115
MT-2460-3	3	24"	60"	30"	155
MT-2472-2	2	24"	72"	30"	125
MT-2472-3	3	24"	72"	30"	162
MT-3048-2	2	30"	48"	30"	112
MT-3048-3	3	30"	48"	30"	150
MT-3060-2	2	30"	60"	30"	130
MT-3060-3	3	30"	60"	30"	175
MT-3072-2	2	30"	72"	30"	140
MT-3072-3	3	30"	72"	30"	184

**MT Series - Mobile Tables** - Designed for shop use, yet attractive enough for an office or a store. All swivel casters provide greater mobility. Reinforced 16 gauge shelves.

■ **Dimensions:** Shelf clearance: two shelf model 21"; three shelf model 9¾".

■ **Casters:** All swivel 5" x 1¼" polyurethane or 5" x 2" semi-steel casters.

■ **Capacity:** 1,000 lbs. capacity based on evenly distributed load. ■ **Options:** Drawers, cylinder locks on drawers, wheel brakes, floor lock.

**1,000 LB  
CAPACITY**



MT-3048-3

MT-3072-2

### Utility Tables



TU-1925-2

Also Available in Type 304  
Stainless Steel  
(TU Series, Drawerless Only)  
See pg. 4



TU-1925-3

• Shown with  
optional 3" casters



TU-1925-2-1D

### TU Series Utility Tables & Carts

Model	Shelves	Drawers	W	L	Wt.
TU-1323-2	2	-	13"	23"	22
TU-1925-2	2	-	19"	25"	35
TU-1925-2-1D	2	1	19"	25"	50
TU-1925-3	3	-	19"	25"	45
TU-2324-2	2	-	23"	24"	46
TU-2324-2-1D	2	1	23"	24"	61
TU-2324-3	3	-	23"	24"	60
TU-2028-2	2	-	20"	28"	47
TU-2028-2-1D	2	1	20"	28"	62
TU-2028-3	3	-	20"	28"	62
TU-2436-2	2	-	24"	36"	63
TU-2436-2-1D	2	1	24"	36"	78
TU-2436-3	3	-	24"	36"	86

**TU Series - Utility Tables & Carts** - These all welded units include back and side stops on shelves to prevent parts and other items from rolling off. Sturdy drawers furnished with padlock loops. All models available with stem casters or floor pads. See page 40 for additional sizes and models.

■ **Dimensions:** 31"H w/ floor pads, 34"H w/ casters, drawer: 14"W x 16"D x 5"H.

■ **Casters:** Optional (4 swivel) 3" or 5" rubber casters.

■ **Capacity:** 300 lbs. w/3" casters, 500 lbs. w 5" casters.

■ **Options:** Casters, floor pads, wheel brakes, cylinder lock on drawer.

### Low Tables / Carts



LPAS-1323



LPAS-1616

**LPAS Series - Low Portable Assembly Stools / Carts** - For general maintenance and assembly use. Flat top shelf, drop front on second shelf for easy sliding and carrying parts and tools.

■ **Dimensions:** LPAS-1616 16" W x 16" D x 14" H, LPAS-1323 13" W x 23" D x 14" H.

■ **Casters:** (4 swivel) 3" x 1" rubber casters.

■ **Capacity:** 300 lbs.

■ **Weight:** LPAS-1616 19 lbs., LPAS 1323 22 lbs.

# F Series Welded Steel Benches

BENCHES • WELDED STEEL



**F-2872**

**F Series - Welded Steel Benches** - All models are constructed of 12 gauge steel tops & legs. 16 gauge stringers & shelves. The top, stringer & legs are reinforced for extra strength. No assembly is required. Standard height is 32 1/2", optionally 34" high. All benches 96" or longer have additional center legs. Shelves are 15 1/4" D. Drawer units are 14" W x 16" D x 5" H.

■ **Options:** Adjustable Legs, electrical knockouts, 34" height, cylinder lock on drawers.



All benches are available with heavy duty adjustable legs. Workbench height adjusts from 32 1/2" to 37 1/2" on 1" centers.



**FS-2872**



**FD-2872**



**FSD-2872**



• Shown in Pucel dark blue, putty, red, & dark green

F Series - Basic Bench				FS Series - Basic Bench + Shelf				FD Series - Basic Bench + Drawer				FSD Series - Basic Bench + Shelf & Drawer			
Model	D	W	Wt.	Model	D	W	Wt.	Model	D	W	Wt.	Model	D	W	Wt.
F-2448	24"	48"	107	FS-2448	24"	48"	125	FD-2448	24"	48"	132	FSD-2448	24"	48"	150
F-2460	24"	60"	120	FS-2460	24"	60"	142	FD-2460	24"	60"	145	FSD-2460	24"	60"	167
F-2472	24"	72"	134	FS-2472	24"	72"	160	FD-2472	24"	72"	159	FSD-2472	24"	72"	185
F-2496	24"	96"	180	FS-2496	24"	96"	214	FD-2496	24"	96"	205	FSD-2496	24"	96"	239
F-24120	24"	120"	195	FS-24120	24"	120"	235	FD-24120	24"	120"	230	FSD-24120	24"	120"	270
F-2848	28"	48"	118	FS-2848	28"	48"	132	FD-2848	28"	48"	143	FSD-2848	28"	48"	157
F-2860	28"	60"	132	FS-2860	28"	60"	150	FD-2860	28"	60"	157	FSD-2860	28"	60"	175
F-2872	28"	72"	148	FS-2872	28"	72"	170	FD-2872	28"	72"	173	FSD-2872	28"	72"	195
F-2896	28"	96"	198	FS-2896	28"	96"	229	FD-2896	28"	96"	223	FSD-2896	28"	96"	253
F-28120	28"	120"	215	FS-28120	28"	120"	255	FD-28120	28"	120"	250	FSD-28120	28"	120"	290
F-3448	34"	48"	132	FS-3448	34"	48"	150	FD-3448	34"	48"	158	FSD-3448	34"	48"	176
F-3460	34"	60"	148	FS-3460	34"	60"	170	FD-3460	34"	60"	174	FSD-3460	34"	60"	196
F-3472	34"	72"	164	FS-3472	34"	72"	186	FD-3472	34"	72"	189	FSD-3472	34"	72"	211
F-3496	34"	96"	220	FS-3496	34"	96"	250	FD-3496	34"	96"	245	FSD-3496	34"	96"	275
F-34120	34"	120"	250	FS-34120	34"	120"	280	FD-34120	34"	120"	275	FSD-34120	34"	120"	315

# B Series Welded Steel Benches



**3,000 LB  
CAPACITY**



### B Series - Welded Steel Benches -

All models feature side and back stops. Constructed of 12 gauge steel tops & legs. 16 gauge stringers & shelves. No assembly is required. The top, stringer & legs are reinforced for extra strength. Standard height is 32 1/2", optionally 34" high. Benches 96" or longer have additional center legs. Shelves are 15 1/4" D. Drawer units are 14" W x 16" D x 5" H.

■ **Options:** Adjustable Legs, electrical knockouts, 34" height, cylinder lock on drawers.

**B-2872**



**BS-2872**



**BD-2872**



**BSD-2872**



All 96" & 120" Long Benches  
Consist of 3 Leg Pairs

**BENCHES • WELDED STEEL**

B Series - Basic Bench				BS Series - Basic Bench + Shelf				BD Series - Basic Bench + Drawer				BSD Series - Basic Bench + Shelf & Drawer			
Model	D	W	Wt.	Model	D	W	Wt.	Model	D	W	Wt.	Model	D	W	Wt.
B-2448	24"	48"	108	BS-2448	24"	48"	126	BD-2448	24"	48"	133	BSD-2448	24"	48"	151
B-2460	24"	60"	121	BS-2460	24"	60"	143	BD-2460	24"	60"	146	BSD-2460	24"	60"	168
B-2472	24"	72"	135	BS-2472	24"	72"	161	BD-2472	24"	72"	160	BSD-2472	24"	72"	186
B-2496	24"	96"	181	BS-2496	24"	96"	215	BD-2496	24"	96"	206	BSD-2496	24"	96"	240
B-24120	24"	120"	196	BS-24120	24"	120"	236	BD-24120	24"	120"	231	BSD-24120	24"	120"	272
B-2848	28"	48"	119	BS-2848	28"	48"	133	BD-2848	28"	48"	144	BSD-2848	28"	48"	158
B-2860	28"	60"	133	BS-2860	28"	60"	151	BD-2860	28"	60"	158	BSD-2860	28"	60"	176
B-2872	28"	72"	149	BS-2872	28"	72"	171	BD-2872	28"	72"	174	BSD-2872	28"	72"	196
B-2896	28"	96"	199	BS-2896	28"	96"	229	BD-2896	28"	96"	224	BSD-2896	28"	96"	254
B-28120	28"	120"	216	BS-28120	28"	120"	256	BD-28120	28"	120"	251	BSD-28120	28"	120"	292
B-3448	34"	48"	133	BS-3448	34"	48"	151	BD-3448	34"	48"	159	BSD-3448	34"	48"	177
B-3460	34"	60"	149	BS-3460	34"	60"	171	BD-3460	34"	60"	175	BSD-3460	34"	60"	197
B-3472	34"	72"	166	BS-3472	34"	72"	188	BD-3472	34"	72"	191	BSD-3472	34"	72"	213
B-3496	34"	96"	222	BS-3496	34"	96"	252	BD-3496	34"	96"	247	BSD-3496	34"	96"	277
B-34120	34"	120"	251	BS-34120	34"	120"	281	BD-34120	34"	120"	276	BSD-34120	34"	120"	317

Call Us Toll Free At 1-800-336-4986 for a Distributor Near You

## Knock Down Steel Top Work Benches



### KD Series - Knock Down Steel Top Work Bench

Model	D	W	Wt.
KD-2448	24"	48"	107
KD-2460	24"	60"	120
KD-2472	24"	72"	134
KD-2848	28"	48"	118
KD-2860	28"	60"	132
KD-2872	28"	72"	148
KD-3448	34"	48"	132
KD-3460	34"	60"	148
KD-3472	34"	72"	164

**KD Series - Knock Down Steel Top Work Benches** - Reinforced welded top furnished with channels for easy leg attachment. Sturdy reinforced legs with floor pads that can be anchored to the floor. Bolts, washers, and nuts are furnished. Elongated holes facilitate fast assembly. 12 gauge steel top and legs, 16 gauge steel stringers. Overall 32½" high. Optional drawers, side and back stops installed at factory. For details on all workbench options and accessories, see pages 38-39.

■ **Options:** Adjustable legs, drawers, shelves, side & back stops, electrical knock-outs, risers & pigeon hole units.

## Knock Down Wood Top Work Benches



### W Series - Knock Down Work Bench

Model	D	W	Wt.
W-2448	24"	48"	107
W-2460	24"	60"	124
W-2472	24"	72"	138
W-3048	30"	48"	127
W-3060	30"	60"	147
W-3072	30"	72"	166
W-3096	30"	96"	226
W-30120	30"	120"	264
W-30144	30"	144"	296
W-3648	36"	48"	143
W-3460	36"	60"	167
W-3672	36"	72"	188
W-3696	36"	96"	256
W-36120	36"	120"	295
W-36144	36"	144"	344

**W Series - Knock Down Work Benches** - These benches available with hardwood, composition, or laminate top, two bench legs, and one stringer. A third leg is added for units 96" or longer. Bench includes bolts, nuts, lag screws, and washers. All parts are provided for easy assembly. Benches are 34¼" overall height. For details on all work bench options and accessories, see pages 38-39

■ **Options:** Drawers, cabinets, backboards, shelves, side & back stops, electrical knock-outs, risers & pigeon hole units.



All benches are available with heavy duty adjustable legs. Workbench height adjusts from 32 ½" to 37 ½" on 1" centers.



All 96" & 120" Long Benches Consist of 3 Leg Pairs





**HBS & HBW Series - Ergonomic Hydraulic Work Benches** - These ergonomic benches allow operators to adjust their work surface to accommodate specific height needs with ease. Benches can be ordered with 8", 12" or 16" height adjustment. 16" adjustment available on benches 34" deep or larger. Available with manual crank handle or electric adjustment. The manual crank folds under bench when not in use. The electric unit can adjust height with the push of a button.

■ **Capacity:** 1,000 lbs. capacity for 8" & 12" adjustment, 750 lbs. capacity for 16" adjustment.

■ **Options:** Drawers, side & back stops, cabinets, riser shelf & pigeon hole units

**HBW Series - Hardwood Top Hydraulic Benches**

Model	Manual	Electric	W L		Man.	Elec.
	Suffix	Suffix	W	L	Wt.	Wt.
HBW-3048	M8, M12	E8, E12, E16	30"	48"	178	196
HBW-3060	M8, M12	E8, E12, E16	30"	60"	203	221
HBW-3072	M8, M12	E8, E12, E16	30"	72"	227	245
HBW-3096	M8, M12	E8, E12, E16	30"	96"	311	329
HBW-30120	M8, M12	E8, E12, E16	30"	120"	359	377
HBW-3648	M8, M12, M16	E8, E12, E16	36"	48"	194	212
HBW-3660	M8, M12, M16	E8, E12, E16	36"	60"	222	240
HBW-3672	M8, M12, M16	E8, E12, E16	36"	72"	249	267
HBW-3696	M8, M12, M16	E8, E12, E16	36"	96"	341	359
HBW-36120	M8, M12, M16	E8, E12, E16	36"	120"	394	412

**HBS Series - Steel Top Hydraulic Benches**

Model	Manual	Electric	W L		Man.	Elec.
	Suffix	Suffix	W	L	Wt.	Wt.
HBS-2848	M8, M12	E8, E12, E16	28"	48"	169	187
HBS-2860	M8, M12	E8, E12, E16	28"	60"	187	205
HBS-2872	M8, M12	E8, E12, E16	28"	72"	204	222
HBS-2896	M8, M12	E8, E12, E16	28"	96"	280	298
HBS-28120	M8, M12	E8, E12, E16	28"	120"	316	334
HBS-3448	M8, M12, M16	E8, E12, E16	34"	48"	186	204
HBS-3460	M8, M12, M16	E8, E12, E16	34"	60"	206	224
HBS-3472	M8, M12, M16	E8, E12, E16	34"	72"	226	244
HBS-3496	M8, M12, M16	E8, E12, E16	34"	96"	310	327
HBS-34120	M8, M12, M16	E8, E12, E16	34"	120"	349	367

**Bench Top Options - Knock Down & Hydraulic Benches**

Size D W	Hardwood		Composite		Laminate	
	Model	Wt.	Model	Wt.	Model	Wt.
24" 48"	GW-2448	58	PW-2448	60	LW-2448	56
24" 60"	GW-2460	72	PW-2460	75	LW-2460	70
24" 72"	GW-2472	86	PW-2472	90	LW-2472	84
30" 48"	GW-3048	74	PW-3048	75	LW-3048	70
30" 60"	GW-3060	93	PW-3060	94	LW-3060	88
30" 72"	GW-3072	112	PW-3072	113	LW-3072	105
30" 96"	GW-3096	150	PW-3096	150	LW-3096	140
30" 120"	GW-30120	187	PW-30120	188	LW-30120	175
30" 144"	GW-30144	218	PW-30144	NA	LW-30144	210
36" 48"	GW-3648	86	PW-3648	90	LW-3648	84
36" 60"	GW-3660	108	PW-3660	113	LW-3660	105
36" 72"	GW-3672	130	PW-3672	135	LW-3672	126
36" 96"	GW-3696	174	PW-3696	180	LW-3696	168
36" 120"	GW-36120	216	PW-36120	225	LW-36120	210
36" 144"	GW-36144	260	PW-36144	NA	LW-36144	252



**Hard Wood Top**



**Composition Top**



**Laminate Top**



**EDB-3060**

**EDB Series - Drawer Side Work Stations** - With 14" x 24" x 4" drawers. Cabinet rests on 6" high base. Drawers are equipped with 1" deep tray to hold small items. Bench riser features pegboard back and electrical outlet strip. These benches are 33" deep and 33 1/2" high to work surface. See pages 38-39 for additional accessories ■ **Dimensions:** 33 1/2" H. ■ **Options:** Steel, composite or laminate tops.

<b>EDB Series - Side Drawer Work Stations</b>			
Model	D	W	Wt.
EDB-3048	30"	48"	256
EDB-3060	30"	60"	276
EDB-3072	30"	72"	296



**EWB-3060**

**EWB Series - Solid Side Work Stations** - Features bench riser shelf with pegboard back for hanging small items, and an electrical outlet strip. See pages 38-39 for additional accessories. ■ **Dimensions:** . 30" D x 33" H. ■ **Options:** Steel, composite or laminate tops.

<b>EWB Series - Solid Side Work Stations</b>			
Model	D	W	Wt.
EWB-3048	30"	48"	170
EWB-3060	30"	60"	190
EWB-3072	30"	72"	210



**EWS-3060**

**EWS Series - Center Drawer Work Stations** - Complete with 4, 14"W x 23 1/2"D x 5"H drawers. Cabinet rests on a 6" high base. Drawers are equipped with a 1" deep tray for small items. Bench riser includes a pegboard back with an electrical outlet strip. See pages 38-39 for other accessories. ■ **Dimensions:** 33 1/2" H. ■ **Options:** Steel, composite or laminate tops.

<b>EWS Series - Drawer Work Stations</b>			
Model	D	W	Wt.
EWS-3048	30"	48"	253
EWS-3060	30"	60"	272
EWS-3072	30"	72"	291



- |  |             |  |               |
|--|-------------|--|---------------|
|  | Gray        |  | Dark Blue     |
|  | Dark Green  |  | Light Blue    |
|  | Vista Green |  | Orange        |
|  | Dark Brown  |  | Red           |
|  | Beige       |  | Putty         |
|  | Yellow      |  | White         |
|  | Black       |  | Custom Colors |

## Arc Welding Benches



**AW-3636-S-DR**



**AW-3636-DR**



**AW-3636-WS-DR**

**AW & AWS Series** - Built for rugged service. The 12 gauge top has side and backstops. Legs are double formed, embossed 14 gauge steel. Shelf is divided into three equal sections for the storage of welding rods. AWS Series include 34" tall shield on 3 sides, with either solid or see-thru filters allowing safe observation. Overall height with shields 68".

■ **Dimensions:** 36" W x 36" D x 34" H.

■ **Weight:** 125 lbs., 140 lbs. w/1416 drawer, 180 lbs. with shield.

■ **Options:** Drawer, cylinder lock, solid shield, see-thru shield.



**GW-3636**

## Gas Welding Benches

**GW Gas Weld Bench** - A sturdy gas welding bench for extra strength and durability. Top is constructed of 12 gauge steel, capable of holding 32 fire bricks (not furnished). Embossed 14 gauge steel legs. 16 gauge shelf divided into three equal sections for rod storage. Pads on bottom to protect floor. Shipped knocked down (some assembly required).

■ **Dimensions:** 36" W x 36" D x 34" H. ■ **Weight:** 95 lbs., 110 lbs. w/1416 drawer.

■ **Options:** Drawer, cylinder lock

## Pro Welding Bench

### PWB Series - Pro Welding Bench

Model	W	D	H	Wt.
PWB - 3624	36"	24"	Adj.	185
PWB - 6036	60"	36"	Adj.	370

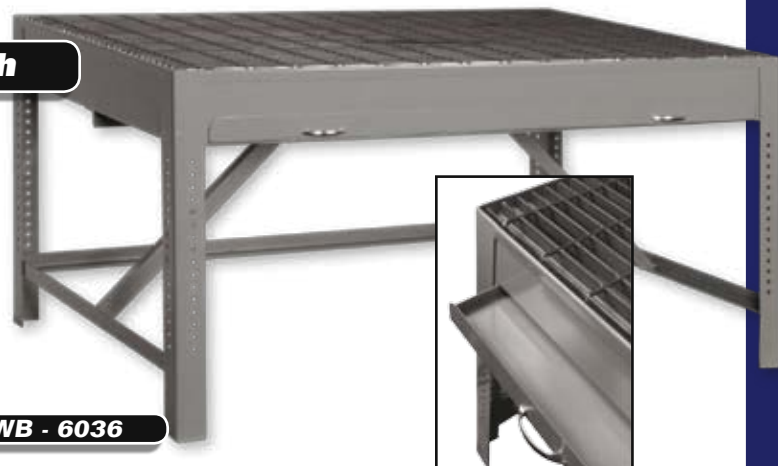

**PWB - 6036**

**PWB Series** - These height adjustable benches accommodate all welding processes: MIG, TIG, GMAW, SMAW, FCAW, GTAW & brazing. Complete removable steel grating. Adjusts from 30" to 42" high to meet the needs of any welder. Convenient pull out tray for easy slag and debris removal. Constructed of all-welded 12 ga. steel with 10 ga. steel legs. No assembly required, ready to use.

**Versatile Modular Work Bench**

**VMW Series - Versatile Modular Bench - Hardwood Top**

Model	W	L	Wt.
VMW-3060-W	30"	60"	147
VMW-3072-W	30"	72"	166
VMW-3660-W	36"	60"	167
VMW-3672-W	36"	72"	188

**VMW Series - Versatile Modular Bench - Steel Top**

Model	W	L	Wt.
VMW-2860-S	28"	60"	132
VMW-2872-S	28"	72"	148
VMW-3460-S	34"	60"	148
VMW-3472-S	34"	72"	164



**VMW Series - Versatile Modular Workbench** allows you to choose components to fit your specific applications. These can easily be adapted or expanded later to meet changing needs. Heavy duty construction accommodates all industrial environments. Benches come with standard stringers.



**VFA Series - Versatile Frame Assembly**

Fits 60" Bench	Wt.	Fits 72" Bench	Wt.
VFA-60	48	VFA-72"	50

**VFA Series - Versatile Frame Assembly** - Frame assembly comes equipped with three uprights. Unit bolts to VMW series bench legs (hardware included).

VMW-3060 shown with versatile frame, light & tool trolley assembly, bin hanger bars and sloped shelf.



**VMW-3060 w/Accessories**

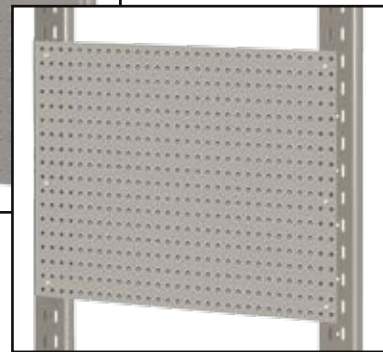
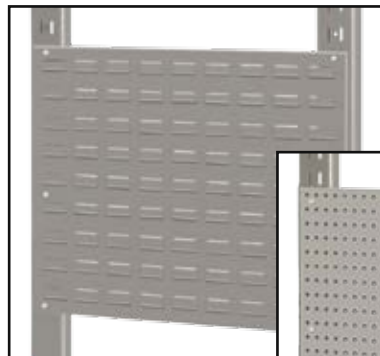

**VPP Series - Versatile Perforated Panel**

Fits 60" Bench	Wt.	Fits 72" Bench	Wt.
VPP-25	8	VPP-32	10

**VLP Series - Versatile Louvered Panel**

Fits 60" Bench	Wt.	Fits 72" Bench	Wt.
VLP-25	9	VLP-32	11

**VLP Series - Versatile Louvered Panel** - Steel 18" W x 27 1/2" or 34 1/2" High panel can be bolted easily to workbench uprights. Accommodates industry standard plastic bins or spindles.

**LTA Series - Light & Tool Trolley Assembly**

60" Bench	Fixture	Wt.	72" Bench	Fixture	Wt.
LTA-60-2	2 bulb 1'x 4'	55	LTA-72-2	2 bulb 1'x4'	59
LTA-60-4	4 bulb 2'x4'	59	LTA-72-4	4 bulb 2'x4'	63

**LTA Series Light & Tool Trolley Assembly** - This assembly mounts to VFA frame assembly. Comes with enclosed fluorescent light fixture (bulbs included). Lights are 48" long, can be ordered with two bulbs or four bulbs. Two trolleys and a rail are provided to hold tools or balancers conveniently.

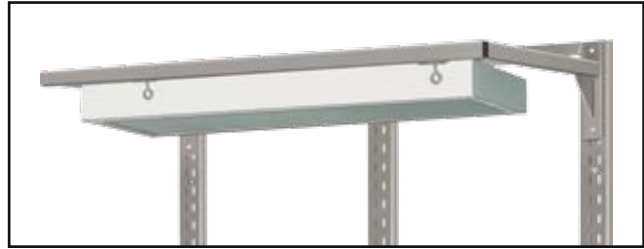

**VHB Series - Versatile Hanger Bar**

Fits 60" Bench	Depth	Wt.	Fits 72" Bench	Depth	Wt.
VHB-25-1	1"	2	VHB-32-1	1"	3
VHB-25-5	5"	3	VHB-32-5	5"	3
VHB-25-8	8"	3	VHB-32-8	8"	4

**Versatile Hanger Bar** - Hanger bars hold bins and can be easily moved to proper height and location on bench. Available in 3 convenient depths.

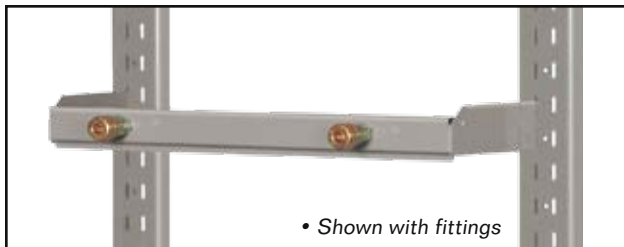
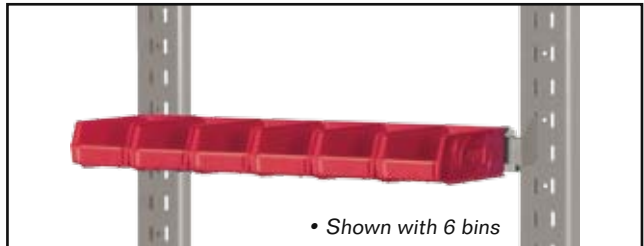

**Air Hanger Bar** - Bracket for air hose can be positioned at desired location. Accommodates two fittings. Quick-connect fittings not included

**AHB Series - Air Hanger Bar**

Fits 60" Bench	Wt.	Fits 72" Bench	Wt.
AHB-25	2	AHB-32	3



**Versatile Shelves** - Versatile shelves are made from heavy gauge steel. Available in 25" or 32" wide; 8", 12" or 15" deep.

**VS Series - Flat Versatile Shelves**

Fits 60" Bench	Depth	Wt.	Fits 72" Bench	Depth	Wt.
VS-25-8	8"	9	VS-32-8	8"	11
VS-25-12	12"	11	VS-32-12	12"	14
VS-25-15	15"	12	VS-32-15	15"	16



**Electrical Hanger Bar** - Includes a switchable 6-outlet surge protector. Protects your electronic equipment from power line disturbances.

**EHB Series - Electrical Hanger Bar**

Fits 60" Bench	Wt.	Fits 72" Bench	Wt.
EHB-25	4	EHB-32	4



**VSS Series - Sloped Versatile Shelves**

Fits 60" Bench	Depth	Wt.	Fits 72" Bench	Depth	Wt.
VSS-25-8	8"	10	VSS-32-8	8"	12
VSS-25-12	12"	12	VSS-32-12	12"	15
VSS-25-15	15"	13	VSS-32-15	15"	17

## Stops, Shelves & Stringers

### ST Series - Bench Stringers

Model	D	W	Bench Size	Wt.
ST-36	4¼"	32"	36"	4
ST-48	4¼"	44"	48"	6
ST-60	4¼"	56"	60"	8
ST-72	4¼"	68"	72"	9
ST-96	4¼"	92"	96"	12
ST-120	4¼"	116"	120"	15
ST-144	4¼"	140"	144"	18

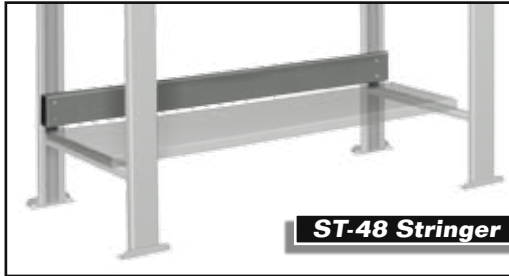

**ST-48 Stringer**

**ST Series Bench Stringers** - Bench stringer constructed of 16 gauge steel. Provides further rigidity to bench legs. Attaches easily to Pucel benches. 1" formed channel reinforced construction. Fasteners included.

### SH Series - Bench Shelves

Model	D	W	Bench Size	Wt.
SH-36	15¼"	32"	36"	13
SH-48	15¼"	44"	48"	18
SH-60	15¼"	56"	60"	22
SH-72	15¼"	68"	72"	26
SH-96	15¼"	92"	96"	34
SH-120	15¼"	116"	120"	42
SH-144	15¼"	140"	144"	50

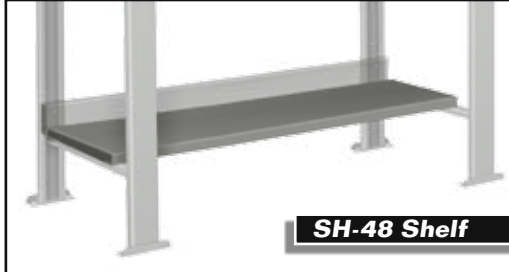

**SH-48 Shelf**

**SH Series - Bench Shelves** - Bench shelves constructed of 16 gauge steel. 1" formed channel reinforced construction. Attaches easily, comes complete with fasteners.

### Side & Back Stops

Model	D	W	Wt.	Model	D	W	Wt.
2436	24"	36"	14	30120	30"	120"	32
2448	24"	48"	16	30144	30"	144"	36
2460	24"	60"	18	3648	36"	48"	22
2472	24"	72"	20	3660	36"	60"	24
3048	30"	48"	20	3672	36"	72"	26
3060	30"	60"	22	3696	36"	96"	31
3072	30"	72"	24	36120	36"	120"	35
3096	30"	96"	29	36144	36"	144"	39



**2448-Side & Back Stops**

**Side & Back Stops** - Each set consists of two side stops, (right and left), and one back stop. Constructed of 12 gauge steel.



**R-48**

### R - Bench Risers

Model	L	Wt.
R-36	36"	15
R-48	48"	19
R-60	60"	23
R-72	72"	27
R-96	96"	34

**R-36 - R96 Bench Riser Shelf** - ■ **Dimensions:** All 12" High, 10" Deep.



**2024-SDU**

### SDU Series - Stacking Drawer Units

Model	W	D	Wt.
1416-SDU	17¾"	16¼"	25
1424-SDU	17¾"	24¼"	33
2024-SDU	23¾"	24¼"	38

**SDU Series - Stacking Drawer Units** - These drawers can be mounted side by side, or stacked and bolted together. They can be fastened to either wood or steel benches, tables, desks, or counters. Padlock hasp for each drawer. Telescoping, full extension ball bearing drawer slides. Sliding tray in each drawer is 13½" x 8" x 1" deep in 1416 and 1424 series and 19½" x 8" x 1" deep in 2024 series. All models are 6¾" high.  
 ■ **Dimensions:** All models 6¾" H  
 ■ **Options:** Cylinder locks, recessed handles.



**P-36**

### P - Pigeon Holes

Model	Opngs.	Wt.
P-36	3	15
P-66	6	24
P-48	4	18
P-88	8	27

**P-36 - P66 Pigeon Hole Units** -  
 ■ **Dimensions:** P-36: 36"W x 9"D x 7"H, P-66: 36"W x 9"H x 11", Openings: 4" x 12"

**P-48 - P88 Pigeon Hole Units** -  
 ■ **Dimensions:** P-48: 48"W x 9"D x 7"H, P-88: 48"W x 9"H x 11"H, Openings: 4" x 12"



**ABL**

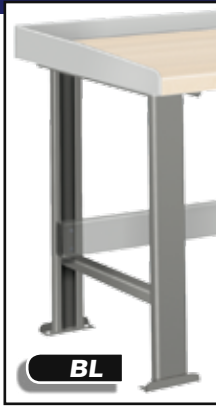

**BL**

**BL Series - Bench Legs** - These sturdy all steel legs are designed for maximum support. Top and cross members are permanently welded to legs. Holes are provided to attach bench top, shelf, and stringer. Steel floor pads have holes for anchoring to floor surface. BL-58 bench leg is furnished with a center upright channel. Duplex electrical receptacle punchout available. BL legs are 32-1/2" high.

**ABL Series - Adjustable Bench Legs** - Legs adjust from 32-1/2" to 37-1/2" on 1" centers. Holes are provided for attachment of bench top, shelf, and stringer. Steel floor pads have holes for anchoring to floor. Constructed of 12 gauge steel. Receptacle punchout available.

**Drawer Units**



**1416-1**



**1416-2**



**1416-3**

**Bench Drawer Units**

Model	W	D	H	Drws.	Wt.
1416-1	15½"	16"	5½"	1	15
1416-2	15½"	16"	12½"	2	45
1416-3	15½"	16"	18½"	3	66
1416-4	15½"	16"	24½"	4	87
1424-1	15½"	24"	5½"	1	26
1424-2	15½"	24"	12½"	2	60

Model	W	D	H	Drws.	Wt.
1424-3	15½"	24"	18½"	3	90
1424-4	15½"	24"	24½"	4	120
2024-1	21½"	24"	5½"	1	30
2024-2	21½"	24"	12½"	2	74
2024-3	21½"	24"	18½"	3	105
2024-4	21½"	24"	24½"	4	136



**1416, 1424 & Series - Drawer units** - Easily fastened to either wood or steel benches, tables, carts, trucks or desks. Includes chrome pull handles (pictured with recessed handles), padlock loop eyes furnished with each drawer. Drawer slides effortlessly on telescoping, full extension ball bearing glides. Small parts tray in each drawer holds small items within easy reach.

■ **Options:** Cylinder locks, recessed pull handles.

**Cabinet Units**



**CU-18**

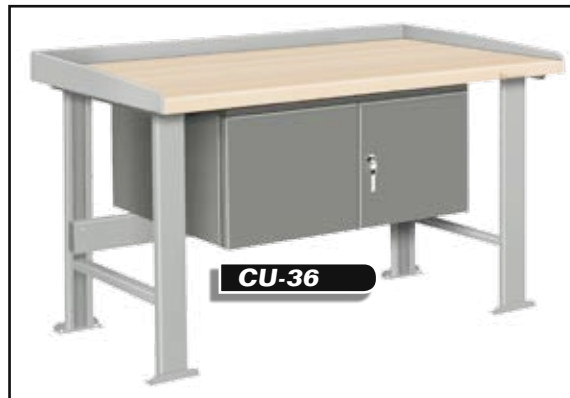

**CU-36**

**CU Series - Cabinet Units** - CU series cabinets mount easily to the underside of wood top benches. These have 1 fixed shelf.

■ **Dimensions:** CU-18, 18" W x 19" W x 19" H., CU-36: 36" W x 19" D x 19" H. ■ **Weight:** CU-18, 42 lbs., CU-36, 60 lbs.

■ **Options:** Keyed handle locks.

Utility Tables



TU-1925-2-1D  
w/3" casters



TU-1925-3-1D  
w/3" casters



TU-1925-2-3D  
w/3" casters

Also Available in Type 304  
Stainless Steel  
(TU Series, Drawerless Only)  
See Pg. 4



TU-1925-3  
w/3" casters



TU-1925-2

**TU Series - Utility Carts & Tables** - These all welded units include back and side stops on shelves to prevent parts and other items from rolling off. Sturdy drawers furnished with padlock loops. All models available with stem casters or floor pads.

■ **Dimensions:** 31"H w/ floor pads, 34"H w/ casters, drawer 14" W x 16" D x 5" H.

■ **Casters:** (4 swivel) 3" or 5" soft rubber casters or pads.

■ **Capacity:** 3" casters 300 lbs., 5" casters 500 lbs.

■ **Options:** Wheel brakes on casters, cylinder locks on drawers.

TU Series Utility Tables & Carts

Model	Shelves	Drawers	W	L	Wt
TU-1323-2	2	-	13"	23"	24
TU-1323-3	3	-	13"	23"	30
TU-1925-2	2	-	19"	25"	35
TU-1925-2-1D	2	1	19"	25"	50
TU-1925-2-2D	2	2	19"	25"	80
TU-1925-2-3D	2	3	19"	25"	101
TU-1925-3	3	-	19"	25"	45
TU-1925-3-1D	3	1	19"	25"	60
TU-2324-2	2	-	23"	24"	46
TU-2324-2-1D	2	1	23"	24"	61
TU-2324-2-2D	2	2	23"	24"	91
TU-2324-2-3D	2	3	23"	24"	112
TU-2324-3	3	-	23"	24"	60
TU-2324-3-1D	3	1	23"	24"	72
TU-2028-2	2	-	20"	28"	47
TU-2028-2-1D	2	1	20"	28"	62
TU-2028-2-2D	2	2	20"	28"	92
TU-2028-2-3D	2	3	20"	28"	113
TU-2028-3	3	-	20"	28"	62
TU-2028-3-1D	3	1	20"	28"	74
TU-2436-2	2	-	24"	36"	63
TU-2436-2-1D	2	1	24"	36"	78
TU-2436-2-2D	2	2	24"	36"	108
TU-2436-2-3D	2	3	24"	36"	129
TU-2436-3	3	-	24"	36"	86
TU-2436-3-1D	3	1	24"	36"	98

**BC 1323 Box Cart** - Combines a tote box with a highly maneuverable cart. Easily turns in narrow aisles.

■ **Dimensions:** 6" deep box, clearance between box and shelf 17."

■ **Casters:** (4 swivel) 3" rubber casters ■ **Capacity:** 300 lbs.

■ **Options:** Wheel brakes on casters.

	Gray		Dark Blue
	Dark Green		Light Blue
	Vista Green		Orange
	Dark Brown		Red
	Beige		Putty
	Yellow		White
	Black		Custom Colors



BC-1323-6-2



**Specialty Carts**

**CARTS & TRUCKS**



**TH-14C**

**TH-14 - Hopper Cart** - Designed to aid in the sorting of small parts, etc. Slanted top with lip holds material container, sloped hopper directs items to bottom shelf.  
 ■ **Dimensions:** 14" W x 30" D, front 30" H, rear 36" H. Chute 6" x 12". Clearance between shelf and chute 12".  
 ■ **Casters:** (4 swivel) 3" rubber casters. ■ **Capacity:** 300 lbs.  
 ■ **Weight:** 40 lbs. ■ **Options:** Foot pads, wheel locks.



**SER-101**

**1,000 LB CAPACITY**

**SER - Pull Cart** - Features a 32" long handle. Complete with lock hasp. Drawer slides on telescoping, full extension ball bearing slides. Drawer size 20" W x 15" D x 5" H.  
 ■ **Dimensions:** 16" W x 28" D x 20 1/2" H. Shelves 1" deep.  
 ■ **Casters:** 2 swivel, 2 rigid, 5 x 1 1/4" polyurethane or semi-steel  
 ■ **Capacity:** 1,000 lbs. ■ **Weight:** 60 lbs.  
 ■ **Options:** Cylinder locks, wheel brakes.

**Shop Trucks**



**1,000 LB CAPACITY**

**TSC-1828-12**

• Shown in Pucel putty

**TSC Series - Welded Box Carts** - Constructed of 16 gauge steel with 1/2" hemmed edge.  
 ■ **Dimensions:** Top box 6" or 12" D, Bottom tray 2 1/2" deep, shelf clearance 18". Floor clearance 6".  
 ■ **Casters:** 2 swivel, 2 rigid 5" x 1 1/4" poly or 5" x 2" semi-steel  
 ■ **Capacity:** 1,000 lbs.  
 ■ **Options:** Floor lock, wheel brakes, flat bottom shelf.

**TSC Series - Welded Box Carts**

Model	Box Depth	W	L	H	Wt.
TSC-1828-6	6"	18"	28"	37"	67
TSC-1836-6	6"	18"	36"	37"	74
TSC-2436-6	6"	24"	36"	37"	83
TSC-1828-12	12"	18"	28"	37"	75
TSC-1836-12	12"	18"	36"	37"	85
TSC-2436-12	12"	24"	36"	37"	95



**3,000 LB CAPACITY**

**TT-1830-12**

• Shown in Pucel putty

**TT Series - Heavy Duty Welded Box Trucks** - Easily handles the heaviest loads. Constructed of 12 gauge steel top box 6" or 12" deep with a 1" hemmed edge. 2" bottom tray.  
 ■ **Dimensions:** Clearance between trays 17 3/4", floor clearance 6 1/2".  
 ■ **Casters:** 2 swivel, 2 rigid 5" x 2" phenolic or semi-steel.  
 ■ **Capacity:** 3,000 lbs. ■ **Options:** Floor lock, flat bottom shelf.

**TT Series - Heavy Duty Shop Tray Carts**

Model	Box Depth	W	L	H	Wt.
TT-1830-6	6"	18"	30"	37"	114
TT-2430-6	6"	24"	30"	37"	128
TT-2436-6	6"	24"	36"	37"	140
TT-3036-6	6"	30"	36"	37"	151
TT-2448-6	6"	24"	48"	37"	158
TT-3048-6	6"	30"	48"	37"	180
TT-1830-12	12"	18"	30"	37"	130
TT-2430-12	12"	24"	30"	37"	148
TT-2436-12	12"	24"	36"	37"	161
TT-3036-12	12"	30"	36"	37"	179
TT-2448-12	12"	24"	48"	37"	184
TT-3048-12	12"	30"	48"	37"	208

**Stock Carts**

**1,000 LB  
CAPACITY**



**SC-5362**

• Shown in Pucel dark blue



**SC-5363**



**Optional  
Writing Shelf**

**SC & SCF Available in Type 304  
Stainless Steel**  
See Pg. 4



**SCF-5363**

**SCF & SC Series - Stock Carts**

Model	Shelves	W	L	H	Wt.
SC-5182	2	18"	28"	36"	50
SC-5183	3	18"	28"	36"	65
SC-5362	2	18"	36"	36"	56
SC-5363	3	18"	36"	36"	73
SC-5242	2	24"	36"	36"	66
SC-5243	3	24"	36"	36"	88
SCF-5182	2	18"	28"	36"	50
SCF-5183	3	18"	28"	36"	65
SCF-5362	2	18"	36"	36"	56
SCF-5363	3	18"	36"	36"	73
SCF-5242	2	24"	36"	36"	66
SCF-5243	3	24"	36"	36"	88



**SL- 18 Step Ladder  
Attachment**

**SC & SCF Series - Stock Carts** - Designed for rugged factory use, yet attractive for use in an office or a store. Series SC feature tray top shelf, SCF series are constructed with flat tops. 16 gauge shelves. All trays are 2½" deep.  
**■ Casters:** Casters: 2 swivel, rigid 5" x 1 1/4" polyurethane **■ Capacity:** 1,000 lbs.  
**■ Options:** Drawers, floor lock, wheel brake, flat bottom shelf, writing shelf (SC models only).

**SL-18 & SL-24 - Step Ladder Attachment**  
Simple installation. Bolts to legs at swivel caster end. All steps adjustable. 62" overall height. For 18" and 24" wide carts only.

**Slat Top Trucks**

**2,000 LB  
CAPACITY**



**S-48-DT-3**

• Shown with optional floor lock

**S-DT Series - Heavy Duty Slat Top Trucks**

Model	Shelves	W	L	H	Wt.
S-30-DT-2	2	24"	30"	33½"	117
S-30-DT-3	3	24"	30"	33½"	146
S-36-DT-2	2	24"	36"	33½"	132
S-36-DT-3	3	24"	36"	33½"	167
S-48-DT-2	2	24"	48"	33½"	150
S-48-DT-3	3	24"	48"	33½"	196

**S-DT Series - Slat Top Carts** - Designed for sliding dies and heavy items on and off top with safety to fingers and hands. Use with slings or grabs to easily transfer items. 12 gauge top, formed double channel, **■ Dimensions:** Slats 3" wide, 1½" deep, spaced 1½" apart. Shelf clearance 10-1/8" on 3 shelf model, 22¼" on 2 shelf models. 6½" floor clearance. **■ Capacity:** 2,000 lbs.  
**■ Casters:** 2 swivel, 2 rigid 5" x 2" phenolic or semi-steel casters.  
**■ Options:** Floor lock, wheel lock, flat bottom shelf.



## Heavy Duty Shop Trucks

### DT Series - Heavy Duty Shop Truck

Model	Shelves	W	L	Wt.
1830-DT-2	2	18"	30"	93
1830-DT-3	3	18"	30"	116
1836-DT-2	2	18"	36"	100
1836-DT-3	3	18"	36"	128
1848-DT-2	2	18"	48"	116
1848-DT-3	3	18"	48"	152
1860-DT-2	2	18"	60"	135
1860-DT-3	3	18"	60"	180
2430-DT-2	2	24"	30"	105
2430-DT-3	3	24"	30"	134
2436-DT-2	2	24"	36"	115
2436-DT-3	3	24"	36"	150
2448-DT-2	2	24"	48"	135
2448-DT-3	3	24"	48"	180
2460-DT-2	2	24"	60"	155
2460-DT-3	3	24"	60"	210
3030-DT-2	2	30"	30"	118
3030-DT-3	3	30"	30"	152
3036-DT-2	2	30"	36"	130
3036-DT-3	3	30"	36"	172
3048-DT-2	2	30"	48"	154
3048-DT-3	3	30"	48"	210
3060-DT-2	2	30"	60"	177
3060-DT-3	3	30"	60"	242

3,000 LB  
CAPACITY



2430-DT-2

3036-DT-3



**DT Series - Heavy Duty Shop Trucks** - 12 gauge steel, all welded construction. Designed to handle heavy loads, available in two or three shelf configuration.  
 ■ **Dimensions:** 33½" H, shelf clearance 10-1/8" on three shelf models; 22¼" on two shelf models. Floor clearance 6½".  
 ■ **Casters:** 2 swivel, 2 rigid 5" x 2" phenolic or semi-steel casters. ■ **Capacity:** 3,000 lbs.  
 ■ **Options:** Drawers, floor lock, wheel brakes, tray or flat shelves, writing shelf (tray top models only).

5,000 LB  
CAPACITY



ET-2848-2

ET-3448-3

• Shown in Pucel red with optional floor lock

## Extra Heavy Duty Shop Trucks

### ET Series - Extra Heavy Duty Trucks

Model	Shelves	W	L	Wt.
ET-2448-2	2	24"	48"	220
ET-2448-3	3	24"	48"	275
ET-2460-2	2	24"	60"	240
ET-2460-3	3	24"	60"	305
ET-2472-2	2	24"	72"	260
ET-2472-3	3	24"	72"	335
ET-2848-2	2	28"	48"	230
ET-2848-3	3	28"	48"	290
ET-2860-2	2	28"	60"	255
ET-2860-3	3	28"	60"	325
ET-2872-2	2	28"	72"	280
ET-2872-3	3	28"	72"	365
ET-3448-2	2	34"	48"	256
ET-3448-3	3	34"	48"	325
ET-3460-2	2	34"	60"	286
ET-3460-3	3	34"	60"	370
ET-3472-2	2	34"	72"	316
ET-3472-3	3	34"	72"	415

**ET Series - Extra Heavy Duty Trucks** - For moving extreme loads. Constructed of 12 gauge reinforced steel.  
 ■ **Dimensions:** 36" H with 10" floor clearance. Shelf clearance is 9-5/8" on three shelf model, 21" on two shelf model.  
 ■ **Casters:** 2 swivel, 2 rigid 8" x 2½" phenolic or semi-steel.  
 ■ **Capacity:** 8" phenolic and 8" semi-steel: 5,000 lbs.  
 ■ **Options:** Undershelf drawers, floor lock, wheel brake.

Single & Double End Trucks



18-TRE-48

2,000 LB CAPACITY



18-TR-48



18-TR-48 Offset

• Shown in Pucel red with optional flat bottom shelf

**TR & TRE Series - Single & Double End Trucks** - For stock and general shop use. Push handle at one end or both ends.

■ **Dimensions:** 36" overall height, 22" to top shelf.

■ **Casters:** 2 swivel, 2 rigid. 5" x 2" phenolic or semi-steel

■ **Capacity:** 2,000 lbs.

■ **Options:** Flat bottom shelf, offset handle, wheel brake, floor lock.

TR Series - Single Push Handle Heavy Duty Trucks

Model	W	L	Deck Ht.	Wt.
18-TR-30	18"	30"	22"	98
18-TR-36	18"	36"	22"	106
18-TR-48	18"	48"	22"	122
18-TR-60	18"	60"	22"	140
24-TR-30	24"	30"	22"	110
24-TR-36	24"	36"	22"	120
24-TR-48	24"	48"	22"	140
24-TR-60	24"	60"	22"	160
30-TR-30	30"	30"	22"	125
30-TR-36	30"	36"	22"	135
30-TR-48	30"	48"	22"	160
30-TR-60	30"	60"	22"	185

TRE Series - Double Push Handle Heavy Duty Trucks

Model	W	L	Deck Ht.	Wt.
18-TRE-30	18"	30"	22"	107
18-TRE-36	18"	36"	22"	115
18-TRE-48	18"	48"	22"	131
18-TRE-60	18"	60"	22"	149
24-TRE-30	24"	30"	22"	120
24-TRE-36	24"	36"	22"	130
24-TRE-48	24"	48"	22"	150
24-TRE-60	24"	60"	22"	170
30-TRE-30	30"	30"	22"	136
30-TRE-36	30"	36"	22"	146
30-TRE-48	30"	48"	22"	171
30-TRE-60	30"	60"	22"	196

Ladder Stock Carts



LT-20

2,000 LB CAPACITY



LT-20-78

**LT Series - Ladder Stock Carts** - Complete with a spring loaded ladder, which automatically slides to the floor when operator places their weight on the first step, locking both the ladder and cart to the floor.

■ **Dimensions:** Shelves: Top 20" D x 32" W ; Center 20" D x 36" W ; Bottom 20" D x 41" W. Cart: 20" W x 49" L. Shelves are 2" deep with 13" clearance between the shelves. 6" deep adjustable steps.

■ **Casters:** 2 swivel, 2 rigid 5" x 2" phenolic or semi-steel casters.

■ **Capacity:** 2,000 lbs. ■ **Weight:** LT-20 155 lbs.; LT-20-78 174 lbs.

■ **Options:** Floor lock, wheel brake, flat bottom shelf.

## Additional Carts & Trucks

### IT Series - Instrument Trucks

Model	W	L	Wt.
IT-2436	24"	36"	129
IT-2448	24"	48"	150
IT-3048	30"	48"	163
IT-3060	30"	60"	198

**IT Series - Instrument Truck** - Designed to transport heavy, sensitive and delicate equipment. Moves heavy loads smoothly with 8" pneumatic casters. All welded 12 gauge steel construction. Top shelf is covered with a non-slip ribbed composite rubber mat for safety, traction and shock absorption.

- **Dimensions:** 41½" overall height, top shelf 33½" H.
- **Casters:** 2 swivel, 2 rigid 8" x 2" full pneumatic tires.
- **Capacity:** 1,100 lbs. ■ **Options:** Floor lock, wheel lock, flat bottom shelf.

1,100 LB  
CAPACITY  
PNEUMATIC  
TIRES



• Shown in Pucel light blue



1,000 LB  
CAPACITY

### UT & UC Series - Tote All Trucks

Model	Shelves	W	L	Wt.
UT-2432	1	24"	32"	50
UC-2432	2	24"	32"	59
UT-2442	1	24"	42"	55
UC-2442	2	24"	42"	66
UT-2452	1	24"	52"	60
UC-2452	2	24"	52"	73

**UT & UC Series - Tote-All Trucks** - Constructed from all welded 1-1/16" tubing and 14 gauge channel formed steel.

- **Dimensions:** Deck height as follows: UT 15", UC 28", 36".
- **Casters:** 2 swivel, 2 rigid 5" x 1¼" polyurethane casters.
- **Capacity:** 1,000 lbs. ■ **Options:** Floor lock, wheel lock

1,000 LB  
CAPACITY  
5" POLY  
CASTERS



### PTT Series - Pan & Tray Trucks

Model	Tray W	Slide Space	Tray Capacity	D	H	Wt.
PTT-2430-2	24"	2"	28	30"	66"	199
PTT-2430-4	24"	4"	14	30"	66"	144
PTT-2430-6	24"	6"	9	30"	66"	124
PTT-3030-2	30"	2"	28	30"	66"	204
PTT-3030-4	30"	4"	14	30"	66"	149
PTT-3030-6	30"	6"	9	30"	66"	129
PTT-3630-2	36"	2"	28	30"	66"	209
PTT-3630-4	36"	4"	14	30"	66"	154
PTT-3630-6	36"	6"	9	30"	66"	134

**PTT Series - Pan & Tray Trucks** - Designed to store slide in trays of various sizes. Ideal for medium duty to heavy duty applications. These units are constructed of 1½" x 14 gauge square tubing frame.

- **Dimensions:** 30" D x 66" H, Slides are 1" x 1" steel angle.
- **Casters:** (4 swivel) 5" x 1¼" polyurethane casters.
- **Capacity:** 1,000 lbs. ■ **Options:** Floor lock, wheel lock.



PTT-2430-4

CARTS & TRUCKS

**Shelf Trucks**



**L Series - 5 Shelf Stock Cart** - Large volume capacity stock cart for filling orders and other purposes. Available in tray or flat top configurations (flat top applies to upper shelves).  
 ■ **Dimensions:** Shelves are 2½" deep with 10" clearance  
 ■ **Casters:** (2 swivel, 2 rigid) 5" x 1¼" poly. or 5" x 2" semi steel  
 ■ **Capacity:** 1,000 lbs. ■ **Options:** Floor lock, flat shelves.

**X Series - Expanded Metal Stock Cart** - Large volume capacity stock cart for filling orders and other purposes. Expanded metal provides increased visibility, air circulation and reduces the accumulation of dirt. Bottom shelf is constructed of 12 gauge steel, all other shelves are made from expanded metal with steel frame.  
 ■ **Dimensions:** 10" shelf clearance. All models have an overall height of 56¼". Floor clearance for all units is 9"H.  
 ■ **Casters:** 2 swivel, 2 rigid 5" x 2" phenolic or semi-steel casters.  
 ■ **Capacity:** 2,000 lbs. ■ **Options:** Floor lock, wheel locks.



**H Series - Extra Heavy Duty 5 Shelf Truck** - For large and heavy stock orders. Trays constructed of 12 gauge steel. All trays can be reversed, except for bottom.  
 ■ **Dimensions:** Shelf clearances 12", shelves 2" deep, floor clearance 9½".  
 ■ **Casters:** Available with 2 swivel, 2 rigid 8" x 2" phenolic or 8" x 2" semi-steel.  
 ■ **Capacity:** 3,000 lbs. ■ **Options:** Floor lock, flat shelves.

**L Series - Five Shelf Stock Carts 1,000 lb. Cap.**

Model	W	L	H	Wt.
L-1828	18"	28"	58¾"	105
L-1836	18"	36"	58¾"	119
L-2436	24"	36"	58¾"	144
L-2448	24"	48"	58¾"	181

**X Series - Expanded Metal Stock Carts 2,000 lb. Cap.**

Model	W	L	H	Wt.
X-1828	18"	28"	56¼"	150
X-1836	18"	36"	56¼"	167
X-2436	24"	36"	56¼"	187
X-2448	24"	48"	56¼"	216

**H Series - Heavy Duty Stock Carts 2,000 lb. - 3,000 lb. Cap.**

Model	W	L	H	Wt.
H-2430	24"	30"	68"	219
H-2436	24"	36"	68"	247
H-2448	24"	48"	68"	299
H-2460	24"	60"	68"	355
H-3036	30"	36"	68"	287
H-3048	30"	48"	68"	349
H-3060	30"	60"	68"	413



## 3 Sided Carts & Trucks

CARTS & TRUCKS • 3 SIDED



UP TO  
3,000 LB  
CAPACITY

3ST-2860

**3ST Series - 3 Sided Platform Truck** - See-thru design for visual inspection. Heavily reinforced 12 gauge steel platform. Sides and back are constructed of 3/4" flattened expanded metal.

- **Dimensions:** 12" from floor to deck. 48" from deck to top frame.
- **Casters:** 2 swivel, 2 rigid 8" x 2" phenolic or 8" x 2" semi-steel.
- **Capacity:** 3,000 lbs.
- **Options:** Perforated steel double doors and top, floor lock.



2,400 LB  
CAPACITY

SS-60

**SS Series - Sliding Shelf Truck** - For large or heavy stock orders. See-thru design for visual load inspection. The shelves are easily removed by sliding out of channels, permitting truck to be used for large bulky materials. Standard unit consists of two smooth sliding shelves and fixed bottom shelf.

- **Dimensions:** Shelves slope 2" to the rear, 18" shelf clearance
- **Casters:** 2 swivel, 2 rigid 6" x 2" semi-steel or phenolic.
- **Capacity:** 2,000 lbs. ■ **Options:** Floor lock, wheel brakes.



1,500 LB  
CAPACITY

3SC-36

• Shown in Pucel dark blue

**3SC Series - 3 Sided Stock Cart** - Cage design for maximum visibility. Deck is formed of 12 gauge steel. Perfect for large or bulky items.

- **Casters:** Choice of 2 swivel, 2 rigid 5" x 2" phenolic or semi-steel casters.
- **Capacity:** 1,500 lbs. ■ **Options:** Wheel brakes.



CST-24

**CST-24 - Cage Stock Truck** - Elevated platform eases loading and unloading. Ideal for use in the printing and paper handling industries.

- **Dimensions:** 24 1/2" W x 42" L x 62" H.
- **Casters:** 2 swivel, 2 rigid 5" poly casters.
- **Capacity:** 1,000 lbs.
- **Options:** Floor lock, wheel brakes.

### 3ST Series - 3 Sided Platform Trucks

Model	W	L	H	Wt.
3ST-2448	24"	48"	60"	185
3ST-2460	24"	60"	60"	200
3ST-2472	24"	72"	60"	220
3ST-2848	28"	48"	60"	200
3ST-2860	28"	60"	60"	213
3ST-2872	28"	72"	60"	235
3ST-3448	34"	48"	60"	215
3ST-3460	34"	60"	60"	235
3ST-3472	34"	72"	60"	258

### SS Series - Sliding Shelf Trucks

Model	W	L	H	Wt.
SS-48	37"	56"	66"	266
SS-60	37"	68"	66"	298
SS-72	37"	80"	66"	330

### 3SC Series - 3 Sided Stock Carts

Model	W	L	H	Wt.
3SC-30	24"	30"	60"	105
3SC-36	24"	36"	60"	115
3SC-48	24"	48"	60"	135
3SC-60	24"	60"	60"	155

### CST-24 - Cage Stock Truck

Model	W	L	H	Wt.
CST-24	24 1/2"	42"	62"	135

**Shelf Trucks**

**1,000 LB CAPACITY**



**DOUBLE SIDED**

**DV-2242**

**EST-44**

**DV-2242 - Divided Shelf Truck** - 5 shelf surfaces on each side. All shelves and bottom are pitched to slope toward the center to prevent material from falling off of truck. A solid partition divides this double sided truck. This unit's shelves are 11" deep and slope down 2" to center.

- **Dimensions:** 42" W x 22" D x 55-3/4" H. 12" clearance from bottom to first shelf. The middle three shelves have an 8" clearance.
- **Casters:** 2 swivel, 2 rigid, 5" x 2" phenolic.
- **Capacity:** 2,000 lbs. ■ **Weight:** 200 lbs.
- **Options:** Floor lock, wheel brakes.

**EST-44 - Enclosed Shelf Truck** - 4 shelf surfaces slope 1" to back to prevent materials from falling off. The bottom flat shelf size is 16" x 44". 10" clearance between shelves.

- **Dimensions:** 45" W x 16" D" x 62" H.
- **Casters:** Constructed with 2 swivel, 2 rigid, 5" x 1 1/4" polyurethane casters.
- **Capacity:** 1,000 lbs. ■ **Weight:** 110 lbs.
- **Options:** Floor lock, wheel brakes.

**OST-39 - Open Side Truck** - Consists of three 18" x 39" 18 gauge steel horizontal shelves. 15" clearance between shelves. Includes welded push handles at both ends.

- **Dimensions:** 45" W x 18 1/2" D" 50" H.
- **Casters:** 4 swivel 5" x 1 1/4" polyurethane.
- **Capacity:** 1,000 lbs. ■ **Weight:** 90 lbs.
- **Options:** Floor lock, four point wheel brakes, tray type upper two shelves.

**1,000 LB CAPACITY**



**OST-39**

**Garment Trucks**

**500 LB CAPACITY**



**GT-72**

**GT-72-SD**

• Shown in Pucel putty



**GT Series - Garment Truck**

- SD models have full 20 1/2" wide deck for additional cargo. Very easy to maneuver.
- **Dimensions:** 74" L x 20 1/2" D" x 66" H.
- **Casters:** 4 swivel 5" x 1 1/4" poly. casters.
- **Capacity:** 500 lbs. evenly spaced.
- **Weight:** GT-72; 61 lbs., GT-72-SD 98 lbs.
- **Options:** Floor lock, wheel brakes.



## Slant Front Dump Trucks



### HDT & RODT Series Dump Trucks

Model	D	W	L	Wt.
HDT-42	18"	24"	42"	120
HDT-60	18"	24"	60"	168
RODT-42	18"	24"	42"	130

**HDT & RODT Series - Hand Dump Truck & Roll-Over Dump Truck** - The HDT series front is slanted for easy dumping. Two rigid casters in front, one swivel caster in rear. Easily moved into and out of close, narrow areas. Model RODT-42 features a roll-over bar and handle to give maximum leverage and easily turns over load from horizontal to vertical position. Remains upright, material can be easily removed.

■ **Dimensions:** Height to top of box 23". Height to top of handle 36"

■ **Casters:** HDT; 1 swivel, 2 rigid 4" x 2" or 8" x 2" semi-steel casters.

RODT; 1 swivel, 2 rigid 4" x 2" semi-steel casters

■ **Capacity:** HDT 1,500 lbs., RODT 1,500 lbs.,

■ **Options:** Floor lock, wheel brakes, leakproof box.

### BT & ROBT Series Box Trucks

Model	D	W	L	Wt.
BT-2436	24"	24"	36"	95
BT-2448	24"	24"	48"	115
BT-3036	24"	30"	36"	110
BT-3048	24"	30"	48"	136
ROBT-36	24"	24"	36"	120
ROBT-48	24"	24"	48"	140



**BT Series - Box Truck** - Constructed of 14 gauge steel. Casters mounted in diamond pattern with 1/4" tilt. Unit turns within half of its length.

■ **Dimensions:** Overall height 30"

■ **Casters:** 2 swivel, 2 rigid 5" x 1 1/4" polyurethane. ■ **Capacity:** 1,000 lbs.

■ **Options:** Corner mount caster pattern, floor lock, wheel brakes, leakproof box.

**ROBT Series - Rollover Box Truck** - Constructed of 14 gauge steel, the ROBT features a roll-over bar and handle to give maximum leverage and easily turns over load from horizontal to vertical position.

■ **Dimensions:** Overall height 30"

■ **Casters:** 2 swivel, 2 rigid 5" x 1 1/4" polyurethane. ■ **Capacity:** 1,000 lbs.

■ **Options:** Floor lock, wheel brakes, leakproof box.



### STBT Series See-Thru Box Trucks

Model	D	W	L	Wt.
STBT-2436	24"	24"	36"	84
STBT-2442	24"	24"	42"	92
STBT-2448	24"	24"	48"	97
STBT-3036	24"	30"	36"	93
STBT-3042	24"	30"	42"	101
STBT-3048	24"	30"	48"	121

**STBT Series - See-Thru Box Truck** - Steel mesh sides for visual inspection. Casters mounted in diamond pattern with 1/4" tilt. Unit turns within half of its length.

■ **Casters:** 2 swivel, 2 rigid 5" x 1 1/4" polyurethane. ■ **Capacity:** 1,000 lbs.

■ **Options:** Corner mount caster pattern, floor lock, wheel brakes.

**Platform Trucks**

**1,800 LB  
CAPACITY**

**PT-2454-SE**

\* Shown with rubber bumper

**PT-3060-SE**

**UP TO  
3,000 LB  
CAPACITY**

**PT-2860**

**PT-3460**



**24-PTD-48**

**18-PTD-48**

• Shown with 2 handles

**PT-SE Series - Heavy Duty Single End Platform Truck** - Reinforced 12 gauge steel platform. Platform 12" from floor. Unique 6" rear casters offer easy steering and excellent maneuverability.

■ **Casters:** 2 rigid 8" x 2" & 2 swivel, 6" x 2" mold-on rubber casters.

■ **Capacity:** 1,800 lbs.

■ **Options:** Rubber bumper strip, floor lock, wheel brakes.

**PT-SE Series - Heavy Duty Single Ended Platform Trucks**

Model	W	L	Wt.
PT-2442-SE	24"	42"	136
PT-2454-SE	24"	54"	147
PT-3048-SE	30"	48"	159
PT-3060-SE	30"	60"	172

**PT Series - Steel Platform Truck** -

Durable free moving platform truck to absorb the roughest usage. Reinforced steel platform. Removable tubular push handle.

■ **Casters:** 2 swivel 2 rigid 6" x 2" semi-steel or phenolic, 8" x 2" semi-steel or phenolic.

■ **Capacity:** 6" casters 2,500 lbs., 8¾" casters 3,000 lbs.

■ **Options:** Extra handles, handle sockets on both ends, floor locks, wheel brakes.

**PT Series - Steel Platform Trucks**

Model	W	L	Wt.
PT-2448	24"	48"	110
PT-2848	28"	48"	118
PT-3448	34"	48"	130
PT-2460	24"	60"	121
PT-2860	28"	60"	131
PT-3460	34"	60"	144
PT-2472	24"	72"	133
PT-2872	28"	72"	144
PT-3472	34"	72"	160
PT-2496	24"	96"	155
PT-2896	28"	96"	170
PT-3496	34"	96"	191

**PTD Series - Dolly Platform Trucks** -

Low profile platform truck consists of a steel platform with a removable tubular handle.

■ **Dimensions:** With an overall height of 36". This units deck is 5¾" from floor. Available in 18" and 24" widths.

■ **Casters:** 2 swivel, 2 rigid 4" x 2" semi-steel or phenolic casters.

■ **Capacity:** 1,000 lbs.

■ **Options:** Extra handles, handle sockets on both ends, 2" high tray type platform, floor locks, wheel brakes.

**PTD Series - Dolly Platform Trucks**

Model	W	L	Wt.
18-PTD-30	18"	30"	50
18-PTD-36	18"	36"	57
18-PTD-48	18"	48"	68
18-PTD-60	18"	60"	80
24-PTD-30	24"	30"	56
24-PTD-36	24"	36"	63
24-PTD-48	24"	48"	74
24-PTD-60	24"	60"	85

**WPT & WPT-RE Series -Hardwood Platform Trucks** - All models comprised of 1½" hardwood deck with removable handle. WPT-RE series have a steel frame for side protection. WPT series have no frame.

- **Dimensions:** WPT series trucks feature a 10" deck height, and 36" overall height.
- **Casters:** 2 swivel, 2 rigid 6" x 2" semi-steel or phenolic casters.
- **Capacity:** 6" phenolic; 1,400 lbs., 6" steel 2,500 lbs.

**WPT-RE - Steel Reinforced Hardwood Platform Trucks**

Model	W	L	Wt.
WPT-RE-2448	24"	48"	127
WPT-RE-2460	24"	60"	136
WPT-RE-3448	34"	48"	147
WPT-RE-3460	34"	60"	175

**WPT Series - Hardwood Platform Trucks**

Model	W	L	Wt.
WPT-2448	24"	48"	117
WPT-2460	24"	60"	126
WPT-3448	34"	48"	137
WPT-3460	34"	60"	155

**D Series - Steel Dollies** - Constructed of 12 gauge steel. Sides 2" deep. Floor clearance 5". Dolly equipped with removable handle 36½" long.

- **Casters:** 2 swivel, 2 rigid 4" x 2" semi-steel or phenolic
- **Capacity:** 1,000 lbs.
- **Options:** Flat deck, floor lock, wheel brakes, extra handles.

**D Series - Steel Dollies**

Model	W	L	Wt.
18-D-30	18"	30"	40
18-D-36	18"	36"	44
18-D-48	18"	48"	52
18-D-60	18"	60"	60
24-D-30	24"	30"	45
24-D-36	24"	36"	50
24-D-48	24"	48"	60
24-D-60	24"	60"	72

**SLPT Series - Semi-Live Platform Trucks** - These durable all steel platforms become versatile trucks with the addition of no. 15 jack handle. Removeable handle saves space.

- **Casters:** Dual steerable 8" x 2", 2 rigid 8" x 2" mold-on rubber casters.
- **Capacity:** 2,500 lbs.
- **Options:** Jack handles.

**SLPT Series - Semi-Live Platform Trucks**

Model	W	L	Wt.
SLPT-2448	24"	48"	90
SLPT-2460	24"	60"	106
SLPT-3048	30"	48"	100
SLPT-3060	30"	60"	114
SLPT-3648	36"	48"	112
SLPT-3660	36"	60"	127
No. 15 Jack Handle			35



**WPT-RE-3460**



**WPT-3460**



**18-D-30**



**24-D-30**



**SLPT-3048**

• Shown with handle

**Sheet & Panel Trucks**



**YZ-100**

**YZ-100 - Lumber & Material Truck**  
 - Holds both large sheet goods as well as smaller items on its two integral shelves. Extended push handle aids in mobility. 65" in length including extended handle.  
 ■ **Dimensions:** 42" W x 24" D x 44¾" H.  
 ■ **Casters:** 2 swivel, 2 rigid 6" x 2" mold-on.  
 ■ **Capacity:** 1,200 lbs. ■ **Weight:** 145 lbs.  
 ■ **Options:** Floor lock, wheel brakes.

**1,200 LB CAPACITY**



**YZ-75**

**YZ-75 - Lumber & Material Truck**  
 Heavy duty all welded unit. Uprights separate materials for easy handling. Expanded metal bottom shelf holds smaller items.  
 ■ **Dimensions:** 26" W x 24" L x 39" H.  
 ■ **Casters:** 2 swivel, 2 rigid 6" x 2" mold-on rubber.  
 ■ **Capacity:** 1,200 lbs. ■ **Weight:** 72 lbs.  
 ■ **Options:** Floor lock, wheel brakes.



**SPT-2842**

**SPT-2842 - Panel & Sheet Truck**  
 Used for moving sheet goods, office dividers, etc. End stop on the length of the deck keeps material from sliding off truck. Inclined uprights help to contain material. Decking construction is of ½" plywood.  
 ■ **Dimensions:** 42" W x 28" L x 49" H.  
 ■ **Casters:** 2 swivel, 2 rigid 6" x 2" phenolic  
 ■ **Capacity:** 2,000 lbs. ■ **Weight:** 105 lbs.

**2,000 LB CAPACITY**

**Specialty Carts**



**MFC-25**

**MFC-25 - Cleaning Cart** - Designed to contain buckets, vacuums & cleaning supplies. Features 2 2" sockets to secure long handled items (brooms, mops)  
 ■ **Dimensions:** 25"W x 33"D x 41"H. Bottom deck size, 25"W x 25"D x 2" tray. Accessory box, 22½"W x 10½"D x 8"H.  
 ■ **Casters:** 2 swivel, 2 rigid 5" x 1¼" Poly.  
 ■ **Capacity:** 1,000 lbs. ■ **Weight:** 68 lbs.  
 ■ **Options:** Extra handles, handle sockets on both ends, reversed platform style base.



**TA-24**

• Shown in Pucel red

**TA-24 - Tote-All Hand Truck** - This multi-purpose truck is well suited as a four wheel cart or two wheel hand truck.  
 ■ **Dimensions:** 24" W x 16" D x 28" H. 42" to top of angled tubular handle.  
 ■ **Casters:** 2 8" x 1¼" semi-pneumatic rubber tires & 2 3" x 1¼" hard rubber swivel casters.  
 ■ **Capacity:** 375 lbs. ■ **Weight:** 52 lbs.



**TPH-24**

**TPH-24 - Tote Pan Hand Truck** - Sits level on 4 wheels. Easily maneuvered like a 2 wheeled hand truck or pushed as a cart on four wheels. Gusseted shelves have open front for easy loading and unloading.  
 ■ **Dimensions:** Trays are 24"W x 12"D with 2" sides and back. 12" spacing between shelves.  
 ■ **Casters:** 2 8" x 1¼" semi-pneumatic rubber tires & 2 3" x 1¼" hard rubber swivel casters  
 ■ **Capacity:** 375 lbs. ■ **Weight:** 55 lbs.

## Heavy Duty Long Stock Trucks



**BRT-72**

### BRT Series - Heavy Duty Bar & Rod Truck

- 12 gauge steel deck and 4" channel uprights makes this unit strong enough for transporting the heaviest tubing, pipe, angle, etc. All models 60" overall height. Height above deck 48".

■ **Casters:** 2 rigid, 2 swivel 8" x 2" Semi-steel or mold-on rubber casters.

■ **Capacity:** 3,000 lbs.

■ **Options:** Floor locks, wheel locks.

### BRT Series - HD Bar & Rod Truck

Model	W	L	Wt.
BRT-48	36"	48"	255
BRT-60	36"	60"	275
BRT-72	36"	72"	292



**OFB-84**

### OFB Series - Sheet & Bar Truck

Model	Cradle	L	Wt.
OFB-60	22"	60"	270
OFB-84	22"	84"	294

**OFB Series - Bar Truck** - For bar, tube and angle stock. Unique cradle design allows loading or unloading with fork lift or hoist. ■ **Dimensions:** Cradle 22" W, 33" overall. ■ **Wheels:** 10" x 3" semi-steel center wheels with 8" x 3" semi-steel casters or 16" x 3" mold-on rubber wheels with 10" x 2½" mold-on rubber casters.

■ **Capacity:** 10,000 lbs. with steel wheels, 6,000 lbs. with mold-ons.



**CRA-96**

### CRA Series - Cradle Trucks

Model	Cradle	L	Wt.
CRA-60	23½"	60"	350
CRA-96	23½"	96"	384
CRA-120	23½"	120"	416

**CRA Series - Cradle Truck** - Designed for use with round stock, pipe, tubing, etc. Cradles keep stock positioned for easy loading and unloading. ■ **Dimensions:** Cradle width 23½" W, 33" overall. ■ **Wheels:** 10" x 3" semi-steel center wheels with 8" x 3" semi-steel casters or 16" x 3" mold-on rubber wheels with 10" x 2½" mold-on rubber casters.

■ **Capacity:** 10,000 lbs. with steel wheels, 6,000 lbs. with mold-ons.

CARTS & TRUCKS • BAR & ROD

**S-AFT & D-AFT Trucks**

CARTS & TRUCKS

A FRAME



**S-AFT**



• Detail of D-AFT with HB-200, SP-1, B-0 & B-3



• Shown in Pucel orange

**S-AFT w/LP-300 Louvres**

**S-AFT Series - Single Sided Trucks** - All welded steel construction. Angle iron frame and uprights provide a stable platform for components. Versatile unit holds a variety of trays, hanger bars, spindles and brackets. ■ **Dimensions:** 35" W x 25" D x 65½" H ■ **Casters:** 2 swivel, 2 rigid 6" X 2" phenolic, steel or mold-on rubber. ■ **Capacity:** Phenolic or semi steel 2500 lbs., mold-on 1750 lbs. ■ **Weight:** 112 lbs. ■ **Options:** Floor locks, wheel brakes. Attachments such as: Hanger bars, spindles, tray & brackets.



**D-AFT w/8 OFT Trays**

• Shown with optional floor lock



**D-AFT**

**D-AFT Series - Double Sided Trucks** - Twice the capacity of the S-AFT. The double AFT Series will hold up to fourteen trays. ■ **Dimensions:** 35" W x 40 ½" D x 65½" H. ■ **Casters:** 2 swivel, 2 rigid 6" x 2" or 8" x 2" phenolic, steel or mold-on rubber. ■ **Capacity:** Phenolic or semi steel 2500 lbs., mold-on 6" 1750 lbs. 8" 2,000 lbs. ■ **Weight:** 133 lbs. ■ **Options:** Floor locks, wheel brakes. Attachments such as: Hanger bars, spindles, trays & brackets.

## A Frame Truck Trays & Panels

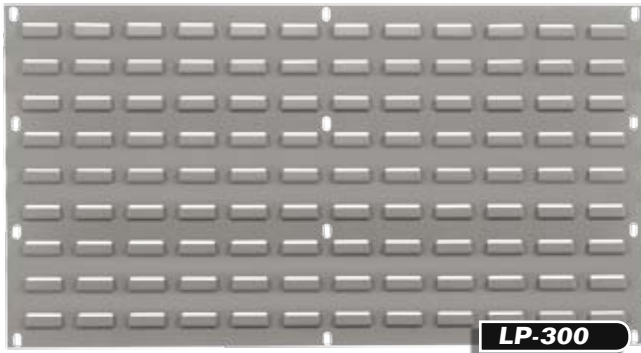

**LP-300 Panels** - Made from 16 gauge steel. These bolt directly to the A-Frame truck. All hardware is included.

■ **Dimensions:** 34" W x 17" H. ■ **Weight:** 11 lbs.

### AFT Series - Accessories

Model	Description	Wt.
B-0	Flat Stock Bracket	7¼
B-3	2" Radius Bracket	7½
SP-5	½" Spindle	1½
SP-62	5/8" Spindle	2
SP-75	¾" Spindle	2½
SP-1	1" Spindle	4
OFT-100	Open Front Tray	18
SOF-101	Semi-Open Front Tray	21
FTT-102	Flat Top Tray	16
PBT-103	Semi-Open Perf. Tray	16



**OFT-100**



**SOF-101**



**FTT-102**



**PBT-103**

**A Frame Trays** - Made from 16 gauge steel. Trays OFT-100, SOF-100 and PBT-103 have two drop handles. Model FTT-102 is a flat shelf 32 ¾" W x 15" D

■ **Dimensions:** 32¾" W x 15" D x 15" D x 6" H.  
 ■ **Capacity:** 500 lbs.

## A Frame Brackets



**HB-200**

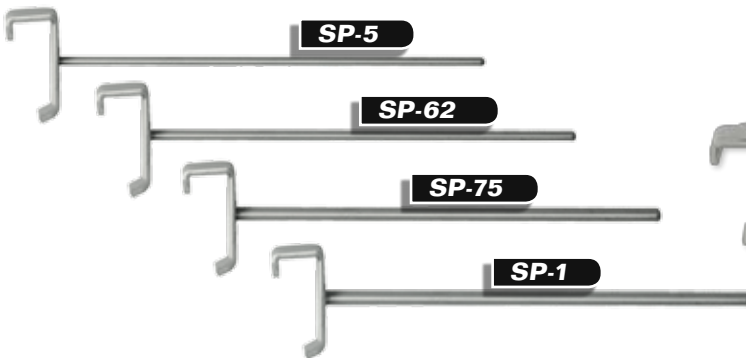

**SP-5**

**SP-62**

**SP-75**

**SP-1**



**B-3**



**B-0**

**HB-200** - Bar attaches to A-Frame truck for mounting the brackets and spindles. The single A-Frame will hold up to 10 bars, D-AFT holds 20 bars. ■ **Dimensions:** 34" W x 4 ½" H ■ **Weight:** 10½ lbs.

**SP Series** - Spindles for handling spools, rings, etc. HB-200 is required for mounting spindles. ■ **Dimensions:** 15" L.

**B-O & B-3** - Brackets for handling tubing, pipe, and flat stock. HB-200 is required for mounting brackets. ■ **Dimensions:** 15" L.





**PBSC-L-36**  
Louvered Panel

**PBSC-36**



**PBSC-P-36**  
Pegboard Panel

**PBSC-36 Series - Portable Cart** - A perfect compliment to any of our Pucel work stations. Parts can be organized and brought to the assembly bench with ease. The convenience of a double sided cart allows everything needed for the job to be on one unit. This cart can easily be adapted or expanded later to meet changing needs.

■ **Dimensions:** 36" W x 24" D x 61" H. ■ **Casters:** ( 2 rigid, 2 swivel ) 5" x 2" semi steel or phenolic. ■ **Capacity:** 2,000 lbs.

■ **Options:** Versatile hanger bar, flat or sloped shelves, plastic bin containers. (See page 37 for options).

**Storage Bins**

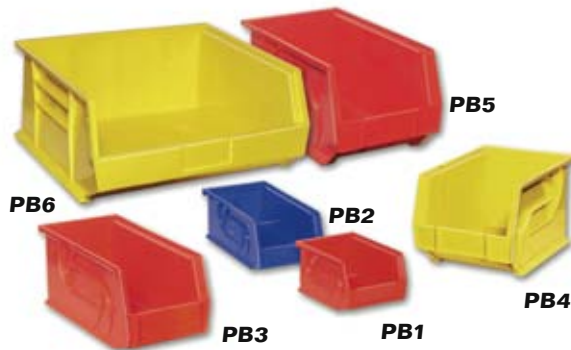

**PB Series Bins**

Bin #	D	W	H
PB1	5"	4"	3"
PB2	7"	4"	3"
PB3	11"	6"	5"
PB4	10"	8"	7"
PB5	14"	8"	7"
PB6	14"	16"	7"



	Gray		Dark Blue
	Dark Green		Light Blue
	Vista Green		Orange
	Dark Brown		Red
	Beige		Putty
	Yellow		White
	Black		Custom Colors





**1,000 LB  
CAPACITY**



**CS Series - Corner Caster Shoes** - Ideal for making wood pallets or boxes portable at low cost. Shoes slide under corners.

Can be bolted, screwed, or nailed permanently. Constructed of 12 gauge steel. Set of 4

■ **Dimensions:** 8" x 8". 5¼" overall height. 2" flange, with 7/16" holes for mounting ■ **Casters:** (4 swivel) 3" x 1¼" semi-steel or hard rubber

■ **Capacity:** CS-3R rubber; 1,000 lbs. CS-3S steel; 1,200 lbs ■ **Weight:** CS-3R 15 lbs., CS-3S 17 lbs.

**Casters**

**Quality Casters** - For original specification or replacement. Casters equipped with zerk grease fittings for lubrication (except soft rubber casters). All casters available with wheel brake, four position or total locking brakes. Pucel equipment is always available with multiple caster options including wheel materials, capacities, widths, sizes, hubs & tires in pneumatic, semi-pneumatic & solid.

■ **1"¼" Polyurethane** - Highly mobile polyurethane tread on composite hub. Excellent for light & medium duty use. Non-marking, non-conductive wears well on most common surfaces. Highly durable industry standard.

■ **Semi-Steel** - High load capacity cast iron wheels on formed & welded steel legs. Longest life on concrete, although not ideal for floor protection.

■ **Mold-on Rubber** - Cushion rubber tread on cast iron hub. Offers additional floor & shock protection.

■ **Phenolic** - Provides best all-around service for heavy loads, non marking, non conductive. Resistant to oils & gasoline.

■ **Polyurethane / Cast Iron** - Extra durable polyurethane tread provides excellent wearability. Superior resistance to most chemicals. Non-marking.

	1 ¼" Polyurethane	Semi Steel	Mold-on & Rubber	Phenolic	Premium Polyurethane	Soft Rubber
3"						
4"						
5"						
6"						
8"						

**Premium Casters**

**Quality Casters** - These precision engineered casters greatly decrease rolling resistance reducing effort and risk of injury. Comprised of ball bearing swivel raceways and wheel hubs these high performance casters carry the total unit's weight on all floor surfaces. Ask your Pucel representative for details.



**Drum Storage**



**85 Series Drum Storage Racks** - These racks hold four drums in readily accessible positions. Designed for loading ease with whatever equipment you may now have. If your hoist does not travel over your rack, the 85-C model can be moved under your hoist.

- **Dimensions:** 60"W x 30" D x 54"H.
- **Casters:** 85-C; 6" x 2" semi steel casters (2 rigid, 2 swivel).
- **Capacity:** 2,500 lbs. ■ **Weight:** 85, 180 lbs. 85C, 198 lbs.



**EZY - Down Drum Cradles** - These heavy duty drum cradles easily position drums from vertical to horizontal position. break the heaviest loaded drums from a vertical to a horizontal position. EBR-18CR features rollers to mix drum contents. Casters provide ease in rotating and positioning the drum while the drum is on the cradle.

- **Dimensions:** 31"W x 18 1/4" D x 18" H
- **Casters & Wheels:** 2 3" semi-steel swivel casters, and 2 3" semi-steel wheels.
- **Capacity:** 700 lbs. ■ **Options:** Extra #18 Handle

**EBR Series - EZY Down Drum Cradles**

Model	Features	Wt.
EBR-18C	Casters	34
EBR-18CR	Rollers/Casters	36



**DS Series - Drum Storage Racks** -Holds four or six drums in readily accessible positions. Designed for loading ease from front or back. Can be moved with fork lift fully loaded. Pads on the bottom legs protect floors.

**DS Series - Drum Storage Unit**

Model	Drum Cap.	W	D	H	Wt.
DS-4	4	60"	36"	48"	120
DS-6	6	84"	36"	48"	200

**VDU-10 - Heavy Duty Drum Stacking Units** - Each unit stacks two drums horizontally. Maximum number of units to be stacked vertically is four. There is a four-way access by fork trucks.

- **Dimensions:** 44 1/4"W x 30"D x 13"H.
- **Capacity:** 1,500 lbs. ■ **Weight:** 84 lbs.





**#81**



**#82G**



**#82**



**#81G**



**#75**

**AD, #70 & #80 Series - Dollies**

Model	Overall Dia.	I.D.	Finish	Wt.
AD-15	Adj.	Adj.	Paint	23
AD-23	Adj.	Adj.	Paint	30
#75	24½"	24"	Paint	19
#76	19½"	19"	Paint	15
#81	24½"	24"	Paint	32
#81-G	24½"	24"	Galv.	32
#82	30½"	24"	Paint	25
#82-G	30½"	24"	Galv.	25
#83	24½"	19"	Paint	22
#83-G	24½"	19"	Galv.	22

**#75 - #83 Series - Drum Dollies** - Large size easy rolling casters permit quick, safe transportation of even the heaviest loaded drums. 24" diameter holds standard 55 gallon drums or other similar size containers. 19" diameter for 30 gallons or smaller containers. Galvanized finish for institutional, food processing and sanitary use. Floor clearance 4" on all models. 2" sides on #82 and #83.  
 ■ **Casters:** (4 swivel) 3" x 1¼" semi-steel or rubber.  
 ■ **Capacity:** 1,000 lbs.



**AD-23**

**AD Series - Drum Dollies** - Adjusts to fit your requirements. For round, square, rectangular or any irregular shaped container. AD-15 adjusts from 14¼" to 19¼". AD-23 adjusts from 23½" to 36½".  
 ■ **Casters:** (4 swivel) 3" x 1¼" semi-steel or rubber  
 ■ **Capacity:** 1,000 lbs.



**LBR-909**

**LBR-909 - Low Drum Dolly Truck** - This low drum truck has a steel tubular T handle. The swivel caster enable excellent maneuverability. The low profile allows easy loading and unloading. Handles 24" diameter drums. LBR-909H Unit with hinged handle.  
 ■ **Dimensions:** 28"W x 33"H 1½" low underslung, 8" above floor.  
 ■ **Casters:** One 3" hard rubber swivel & 2 6" x 2" phenolic wheels.  
 ■ **Capacity:** 800 lbs. ■ **Weight:** 45 lbs.  
 ■ **Options:** Hinged handle.



**DT-25**

**DT-25 - Drum Dolly Truck** - For transporting drums or other containers. Bracket on handle for holding cable or hose. Accessory box welded to handle for storage of tools and parts.  
 ■ **Dimensions:** Accessory box size 6"W x 21"L x 12"H. Deck size 25"W x 25"L x 2"D.  
 ■ **Casters:** 2 rigid, 2 swivel 5" x 2" semi-steel or phenolic.  
 ■ **Capacity:** 2,000 lbs. ■ **Weight:** 63 lbs.



**#71**

**#71 & #73 - High Drum & Can Dollies** - These raised dollies provide a platform to gravity fill buckets and pails. They take up less space than drums in a horizontal position. #71 designed for 55 gal. drums. #73 perfect for 30 gal. drums.  
 ■ **Dimensions:** #71; 24" W. at the top, 30" at bottom, 19½" H. #73; 19" W at the top, 21" at bottom, 19½" H.  
 ■ **Casters:** 4 swivel 3" x 1¼" rubber or semi-steel casters.  
 ■ **Capacity:** Rubber casters 700 lbs., semi-steel 900 lbs. ■ **Weight:** 44 lbs.

**Drum Lifters, Grips & Hooks**



**#80 Drum Up-Ender** - Tilts drums from horizontal to vertical position with ease, speed & safety. Gives maximum leverage for lifting even the heaviest loaded drums.  
 ■ **Weight:** 12 lbs.



**VH-100 Drum Lifter** - Lifts from any angle. Load can be balanced. Easily adapted to lift objects of all shapes or lengths. Automatic "upsetting" of containers by adjusting sliding hoist collar. Holds rigidly even when load sways. Adjustment between jaws 16" minimum to 40" maximum.  
 ■ **Capacity** 1,000 lbs. ■ **Weight:** 24 lbs.



**#24, #25, #26 & #210** - Easy handling by one person. In seconds the hooks can be slid on and tightened into place. Removes just as easily, no wrenches required. No. 210 Double Fork Hook has maximum openings, which permit an outside fork spread of 20-3/4".  
 ■ **Capacity:** Single fork - 3,000 lbs, Double fork - 4,200 lbs.

**Fork Swivel Hooks**

Model	Frame	Opening	Weight
#24	Single	2" x 4"	17
#25	Single	2" x 5"	18
#26	Single	2" x 6"	19
#210	Double	2" x 10"	50

**750 LB CAPACITY**



**#84 Drum Sling** - Lifts drum horizontally. The harder the pull, the tighter the grip on the drum. Use the drum sling to load your Pucel drum rack.  
 ■ **Capacity:** 750 lbs. ■ **Weight:** 11 lbs.



**2,000 LB CAPACITY**



**#235 Vertical Drum Lifter** - For open or closed drums used with fork trucks, chain falls, and hoists. Fast turning crank handle to lock upper jaw to drum top. Holds drum rigidly, even when swaying or when bumped. Lifter moves 55 gallon, 30 gallon, and smaller steel drums.  
 ■ **Capacity:** 2,000 lbs. ■ **Weight:** 32 lbs.

**800 LB CAPACITY**



**#100 Barrel & Drum Truck** - Tubular construction with ball bearing mold-on rubber wheels, absorb shock, provide easy handling and quiet operation. Polymer grip handles. Balanced load exerted on the axle, bearings and wheels, and off the operators arms and shoulders.  
 ■ **Dimensions:** 42" H, 20" W, Toe Plate 5" x 19"  
 ■ **Wheels:** 8" x 2" mold-on rubber wheels  
 ■ **Capacity:** 800 lbs. ■ **Weight:** 58 lbs.

## Hand Trucks

**800 LB  
CAPACITY**



#89



#90, 91



#92, 93



#98

#96 includes chain & storage tray



#96

**#80 - #90 Series Hand Trucks** - Tubular construction with curb jumper, all edges rounded smooth for appearance and safety, ball bearing rubber wheels, absorb shock, provide easy handling and quiet operation. Plastic grip handles. Balanced load exerted on the axle, bearings and wheels, and off the operators arms and shoulders. Specify color when ordering.

• Shown in Pucel dark green, dark blue, putty, & red



#300, 311

### #80 & 90# Series - All Purpose Hand Trucks

Model	H	W	Toe Plate	Cap.	Wheels	Wt.
#89	46"	18"	8" x 14"	250	8" x 1¾" Semi-Pnue.	27
#90	48"	18"	8" x 14"	650	10" x 2¾" Semi-Pnue.	37
#91	48"	20"	8" x 14"	500	10" x 3½" Pnue.	40
#92	48"	18"	8" x 14"	650	10" x 2¾" Semi-Pnue.	30
#93	48"	20"	8" x 14"	500	10" x 3½" Pnue.	42
#96	45"	33"	13" x 25"	650	12" x 3" Semi-Pnue.	52
#98	43"	18"	9" x 18"	800	8" x 2" Mold-On	55

### #300 Series - Premium Beverage Trucks

Model	H	W	Toe Plate	Cap.	Wheels	Wt.
#300	53½"	16"	8¼" x 10½"	650	10" x 2¾" Semi-Pnue.	36
#311	53½"	18"	8¼" x 10½"	500	10" x 3½" Pnue.	35

**#300 Series Beverage Truck** - Easy to push, even under the heaviest loads. Keeps load on the axle and off operators arms. Designed for rugged use on pavement and curbs. Moves up to six cases of small and large containers. Floating axle absorbs shock. Toe plate gives added strength and adequate load bearing area. Narrow tubular frame with polymer hand grips.

**Rack-U-Frame Modules**



**RUF-264**

**5,000 LB CAPACITY**

**RUF Series - Rack-U-Frames**

Model	W	H	Cap.	Wt.
RUF-251	25"	17½"	20,000	266
RUF-640	25"	17½"	60,000	298

**RUF Series - Twin Rack-U-Frames**

Model	W	H	L	Wt.
RUF-262	25"	17½"	24"	65
RUF-263	25"	17½"	36"	70
RUF-264	25"	17½"	48"	76
RUF-244	32"	31"	44"	105



**RUF-251**

• Three RUF-251 shown

**RUF Series - Rack-U-Frames** - U.S. Patent No. 3,581,907, Canadian Patent 930334. Completely assembled ready for use. Formed for strength and stacking tiers. Carrying handle for strength and convenience. Sold individually and used in any combination to meet your needs. For maximum capacity and safety, the units should be installed on a solid, smooth surface, evenly spaced 20 ft., and stacked a maximum of 4 high.

■ **Capacity;** RUF-251 20,000 lbs., RUF-640 60,000 lbs.

**RUF Series - Twin Rack-U-Frames** - U.S. Patent No. 3,581,907, Canadian Patent No. 930334. Used in multiples with fork lifts, as required to provide length and tier height needed for storage. Can be stacked a maximum of four high.

■ **Capacity;** 5,000 lbs



**3,000 LB CAPACITY**

**VB-3684**

**VB-3684 - Vertical Bar Rack** - Provides most efficient storage in limited areas and near jobs for tubing, pipe, rods, etc. Includes four 16 gauge tray shelves for short pieces. Extension beyond front posts 6", top 6-3/8", second 10", third 14". Arms extend 8" beyond each shelf for separation of stock.

■ **Dimensions;** 84"H 36"W 24"D ■ **Capacity;** 3,000 lbs.  
 ■ **Weight;** 110 lbs.



**8,000 LB CAPACITY**

**SRU-342**  
2 units shown

**SRU Series - Stacking Rack Unit** - For space saving economical storage. Stock can be stored in bundles or individual pieces. Each unit is 32" high. Stackable to two high.

■ **Capacity;** 8,000 lbs.

**Stacking Racks**



• Shown in Pucel orange

**SRU Series - Stacking Rack Units**

Model	W	L	Wt.
SRU-232	24"	32"	58
SRU-242	24"	42"	64
SRU-248	24"	48"	67
SRU-332	30"	32"	62
SRU-342	30"	42"	66
SRU-348	30"	48"	69

## Shelf Bin Rack System



**SBT-3672-D**

• SBT-3672  
without door

**SBT Storage Bin Cabinets** - Openings measure 12"W x 20"D x 12" high at back and tapers to 6" high at front. With keyed handle.  
**■ Dimensions:** 21"W x 36"L x 74"H. **■ Weight:** 322 lbs.  
**■ Options:** Cabinet without door.



	Gray		Dark Blue
	Dark Green		Light Blue
	Vista Green		Orange
	Dark Brown		Red
	Beige		Putty
	Yellow		White
	Black		Custom Colors

**RACKS & STORAGE**



**6,000 LB  
TOTAL  
CAPACITY**

**DR-2448**

**PE-1836**



### DR Series - Super Heavy Duty Knock

**Down Adjustable Rack** - Extremely rugged to hold heavy loads. May be assembled individually or in rows. Shelf mounting holes on 2" centers. Super heavy duty, 14 gauge channel reinforced shelves, 10 gauge angle posts. All hardware and X braces included. Oversize pads protect floors. Shipped knock down or assembled at additional charge.

**■ Capacity:** 1,775 lbs. **■ Options:** Extra shelves, extra posts.

### DR Series - Heavy Duty Knock Down Adjustable Shelving

Model	W	L	H	Wt.
DR-1842	18"	42"	72"	170
DR-2448	24"	48"	72"	230

### PE Series - Extra Heavy Duty All Welded

**Rack** - Used for the heaviest tools, dies, and heavy material. Used individually or bolted together in rows. No assembly required, ready to use. Six extra heavy duty 12 gauge shelves. Pads on posts to protect floors

**■ Dimensions:** 10" shelf clearance, 65" high.

**■ Capacity:** 1,000 lbs. per shelf.

**■ Options:** Custom shelf quantity and position.

### PE Series - Extra Heavy Duty All Welded Rack / Shelf Unit

Model	W	L	H	Wt.
PE-1830	18"	30"	65"	180
PE-1836	18"	36"	65"	205
PE-1848	18"	48"	65"	250
PE-2430	24"	30"	65"	215
PE-2436	24"	36"	65"	250
PE-2448	24"	48"	65"	305

**Shelf Bin Rack Systems**

**BR-2436-6-20**

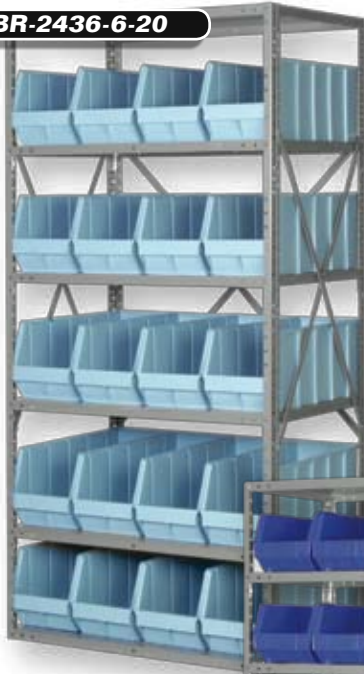

**BR-1836-8-14**



**BR-2436-6-10**



**BR-1826-8-28**



**BR-1236-13-60**



**BR Series Bin Rack Shelving** - These economical Rack & Bin Storage Systems are made of 20 gauge steel and feature a capacity of 400 lbs. per shelf. Shipped unassembled.

■ **Capacity:** 12" x 36" 350 lbs., 18" x 36" 410 lbs., 24" x 36" 450 lbs.

■ **Options:** Extra bins

**BR Series - Shelf Bin Racks**

6 Shelf									
Model	Width	Length	Height	Bins	Bin Model	L	Bin W	Bin H	Weight
BR-2436-6-10	24"	36"	73"	10	PB-2415-12	24"	15"	12"	110
BR-2436-6-20	24"	36"	73"	20	PB-2409-9	24"	9"	9"	115
8 Shelf									
BR-1836-8-14	18"	36"	73"	14	PB-1416-7	14"	16"	7"	131
BR-1836-8-21	18"	36"	73"	21	PB-50	18"	11"	7"	143
BR-1836-8-28	18"	36"	73"	28	PB-1408-7	14"	8"	7"	138
13 Shelf									
BR-1236-13-48	12"	36"	73"	48	PB-1204-8	12"	8"	4"	115
BR-1236-13-60	12"	36"	73"	60	PB-1204-6	12"	6"	4"	121
BR-1236-13-96	12"	36"	73"	96	PB-1204-4	12"	4"	4"	120
BR-1836-13-60	18"	36"	73"	60	PB-1804-7	18"	7"	4"	185
BR-1836-13-96	18"	36"	73"	96	PB-1804-4	18"	4"	4"	188
BR-2436-13-60	24"	36"	73"	60	PB-2404-7	24"	7"	4"	243



## Shelf Racks

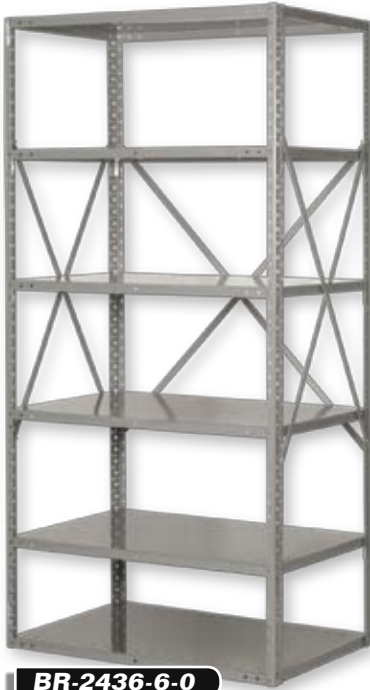

BR-2436-6-0



BR-1236-13-0

**BR Series Shelf Racks** - These economical Rack & Bin Storage Systems are made of 20 gauge steel and feature a capacity of 400 lbs. per shelf. Sized perfectly to accommodate plastic bins. Shipped unassembled.

■ Capacity: 400 lbs. ■ Options: Bins

### BR Series- Shelf Racks

Model	W	L	H	Shelves	Wt.
BR-1236-6-0	12"	36"	72"	6	50
BR-1236-13-0	12"	36"	72"	13	85
BR-1836-6-0	18"	36"	72"	6	74
BR-1836-13-0	18"	36"	72"	13	136
BR-2436-6-0	24"	36"	72"	6	88
BR-2436-13-0	24"	36"	72"	13	166



## Bin Cabinets



PDBC-4872-00-171



PDBC4872-40-128



PDBC-4872-26-84

**All Welded Bin Cabinets** - These flush door and pocket door cabinets are available in a variety of bin configurations. Please see pgs. 10 & 11 for more details.

Model Number .....	Pg.	Model Number.....	Pg.	Model Number.....	Pg.	Model Number.....	Pg.
ABL Series .....	39	ESD-2023 .....	16	PDBC Series.....	11	UC Series.....	45
AD-15.....	59	EST-44.....	48	PDC-36 Series..	27	UGCSC-16..	9
AD-23.....	59	ET Series .....	43	PDC-46-4.....	27	UT Series.....	45
AHB Series.....	37	EWB Series .....	34	PDC-46-8.....	27	VB-3684..	62
AW-3636 Series .....	35	EWS Series .....	34	PE Series.....	63	VDU-10.....	58
B Series.....	31	F Series..	30	PL-1875.....	13	VFA Series.....	36
B-3.....	55	FCD-2839.....	17	PPET-2636.....	18	VH-100.....	60
B-O.....	55	FD Series.....	30	PT Series.....	50	VHB Series.....	37
BC-1323-6-2 .....	40	FDB Series.....	20	PT-SE Series. ....	50	VLP Series.....	36
BC-1 Series .....	14	FS Series.....	30	PTC-48.....	25	VMW Series..	36
BD Series .....	31	FSD Series.....	30	PTD Series. ....	50	VPP Series. ....	36
BDSC Series..	8	FTT-102.....	55	PTT Series.....	45	VS Series .....	37
BDSC Stainless.....	8	GCSC Series.....	9	PUB Series.....	26	VSS Series.....	37
BL Series.....	39	GL Series .....	13	PWB Series .....	35	W Series.....	32
BR Series.....	64,65	GT Series.....	48	R Series.....	38	W-3060-CD.....	18
BRT Series. ....	53	GW-3636.....	35	ROBT Series.....	49	WBC Series.....	15
BS Series .....	31	H Series.....	46	RODT-42.....	49	WC Series..	15
BSC-3675.....	9	HBS Series.....	33	RUF Series.....	62	WPT Series .....	51
BSD Series.....	31	HBW Series.....	33	S-AFT Series.....	54	WPT-RE Series.....	51
BT Series .....	49	HDBC Series.....	10	S-DT Series .....	42	WSC Series.....	12
C Series.....	21	HDSC Drawer Series ...	7	SBT-3672.....	63	X Series.....	46
Casters .....	57	HDSC Series.....	6	SC Series .....	42	YZ-100.....	52
CB Series .....	20	HDSC Stainless.....	5	SC Stainless .....	4,42	YZ-75.....	52
CDB Series. ....	20	HDT Series. ....	49	SCF Series. ....	42	1036.....	16
CF Series.....	23	HDTC Series.....	9	SCF Stainless.....	4,42	1236.....	16
CM Series.....	23	HLTT-36-1.....	22	SCW-3060.....	18	1248.....	16
CRA Series.....	53	HS-2448 - 3472-2.....	28	SD-2860.....	17	1416 - 2024 Drawers .	39
CS Series .....	19	HS-2448 - 3472-3.....	28	SDU Series. ....	38	1436.....	16
CS-3S, CS-3R.....	57	IT Series..	45	SER-101.....	41	1830-2 - 2460-2.....	28
CST-24.....	47	KD Series .....	32	SH Series .....	38	1830-3 - 2460-3.....	28
CT Series.....	23	L Series..	46	SL-18..	42	1836.....	16
CU Series .....	39	LBR-909.....	59	SL-24.....	42	2036.....	17
CW Series..	19	LP-300.....	55	SLPT Series.....	51	2136.....	17
D Series.....	51	LPAS Series..	29	SOF-101.....	55	2236.....	17
D-AFT Series.....	54	LT Series.....	44	SP-1, -5, -62, -75.....	55	2436 - 36144 Stops..	38
DB Series .....	20	LTA Series..	37	SPT-2842.....	52	3036.....	17
DBU Series.....	21	LW-3060-CD.....	18	SRU Series.....	62	3136.....	17
DC-1 Series.....	14	MBCB-52.....	24	SS Series.....	47	3236.....	17
DCF-1 Series.....	14	MDCB-52.....	24	Stainless Section.....	4,5	3SC Series.....	47
DFT Series.....	22	MDD-2448.....	25	ST Series.....	38	3ST Series.....	47
DLCU Series..	12	MFC-25 .....	52	STBT Series.....	49	# 100.....	60
DPL-1621 .....	12	MT Series .....	29	STL Series.....	13	# 210.....	60
DR Series .....	63	MTC-60.....	25	SXHDSC Series. ....	8	# 235.....	60
DS-4.....	58	MTL Series.....	13	TA-24.....	52	# 24 - # 26.....	60
DT Series.....	43	OFB Series.....	53	TH-14.....	41	# 300, # 311 .....	61
DT-25.....	59	OFT-100.....	55	TPH-24.....	52	# 71, # 73.....	59
DTL Series.....	13	OSD-2023 .....	16	TR Series.....	44	# 75 - # 83.....	59
DV-2242.....	48	OST-39 .....	48	TRE Series.....	44	# 80.....	60
EBR-18 Series.....	58	P Series..	38	TSC Series .....	41	# 84.....	60
EDB Series.....	34	PBSC-36 Series .....	56	TT Series .....	41	# 85.....	58
EHB Series.....	37	PBT-103.....	55	TU Series.....	29,40	# 89 - # 98.....	61
EOS-3, EOS-6 .....	37	PC Series .....	26	TU Stainless .....	4,29,40		

*Dependability and Integrity Since 1949*

*Our innovative product line and engineering technology has made Pucel Enterprises, Inc. the industry leader for over 60 years in the material handling equipment field.*

*Pucel is the "Industry Choice" for quality dependable products due to our dedication to excellence, and our corporate vision being keenly focused on your ever changing needs. In this catalog you find equipment and hundreds of products to address your material handling requirements. Please keep in mind, our Research and Development department constantly strives to respond to the needs of our customers. If you do not find a product that specifically addresses your application, please give us a call. Our custom design department will be able to help.*

*Thanks to our dedicated customers we are setting the standard in the industry.*

*Respectfully Yours,  
Pucel Enterprises, Inc.*





**Authorized Distributor**



**© 2010 Pucel Enterprises, Inc.**

**Pucel Enterprises, Inc. • 1440 E. 36th. Street • Cleveland, OH 44114  
(216) 881-4604 • Toll Free (800) 336-4986 • Fax (216) 881-6731  
[www.PucelEnterprises.com](http://www.PucelEnterprises.com)**

***Family Owned and Operated Since 1949***